

HEALTH ASPECTS OF PLUMBING



**World Health
Organization**

WHO Library Cataloguing-in-Publication Data
Health aspects of plumbing.

Published jointly by World Health Organization and World Plumbing Council.

1. Water supply. 2. Water treatment. 3. Waste disposal, Fluid.
4. Sanitary engineering. 5. Guidelines. I. World Health Organization. II. World Plumbing Council.

ISBN 92 4 156318 4

(NLM classification: WA 675)

ISBN 978 92 4 156318 5

© World Health Organization 2006

All rights reserved. Publications of the World Health Organization can be obtained from WHO Press, World Health Organization, 20 Avenue Appia, 1211 Geneva 27, Switzerland (tel: +41 22 791 3264; fax: +41 22 791 4857; email: bookorders@who.int). Requests for permission to reproduce or translate WHO publications – whether for sale or for noncommercial distribution – should be addressed to WHO Press, at the above address (fax: +41 22 791 4806; email: permissions@who.int).

The designations employed and the presentation of the material in this publication do not imply the expression of any opinion whatsoever on the part of the World Health Organization concerning the legal status of any country, territory, city or area or of its authorities, or concerning the delimitation of its frontiers or boundaries. Dotted lines on maps represent approximate border lines for which there may not yet be full agreement.

The mention of specific companies or of certain manufacturers' products does not imply that they are endorsed or recommended by the World Health Organization in preference to others of a similar nature that are not mentioned. Errors and omissions excepted, the names of proprietary products are distinguished by initial capital letters.

All reasonable precautions have been taken by WHO to verify the information contained in this publication. However, the published material is being distributed without warranty of any kind, either express or implied. The responsibility for the interpretation and use of the material lies with the reader. In no event shall the World Health Organization be liable for damages arising from its use.

Designed by minimum graphics
Printed in Switzerland

Contents

Preface	vii
Acknowledgements	ix
Abbreviations and acronyms	x
1. Introduction	1
1.1 Ensuring water safety in production and distribution systems	2
1.2 Removal of liquid waste	3
1.3 Risk of contamination through cross-connections	4
1.4 Periodic inspection	5
2. Basic principles of safe drinking-water supply	6
2.1 Water quantity	6
2.2 Water quality and safety	6
2.3 Public drinking-water supplies	7
3. Hazards in drinking-water supply and waste management	10
3.1 Microbial risks: waterborne infectious disease	10
3.2 Chemical risks	13
3.3 Other risks	15
4. Water safety plans in the operation and management of water systems	18
5. The role of plumbers in risk assessment and risk management	20
5.1 Risk recognition	20
5.2 Risk evaluation and analysis	21
5.3 Risk abatement	21
5.4 Risk acceptance and risk transfer	22
6. Principles of effective plumbing systems	23
6.1 Water supply goals	23
6.2 Liquid waste disposal goals	25
6.3 Plumbing goals	27
7. Codes of practice for plumbing	28
7.1 A sample model code of practice	30
7.2 Applications for approval to install plumbing systems	33
7.3 Setting plumbing standards	34
7.4 Quality assurance and testing	35
7.5 Disinfection of new plumbing installations	37
8. Implementation of the plumbing code of practice	40
8.1 Application and approval process	40

8.2	Certification of conformance	41
8.3	Periodic inspection	42
8.4	Penalties and enforcement	42
8.5	Financial aspects of administration of the plumbing code of practice	43
9.	Training and registration of plumbers	44
9.1	Training prior to admission to the plumbing trade	44
9.2	Licensing and registration	45
9.3	Establishing a training programme	45
10.	Standards for materials used in plumbing systems	46
10.1	Standards	46
10.2	Products and materials used in plumbing	47
10.3	Metallic and non-metallic materials used in pipework	49
10.4	General issues related to use of plastic piping	52
10.5	Earthenware pipes	53
10.6	Design of plumbing fixtures	54
10.7	Sanitary fixtures	55
10.8	Concrete products	55
11.	Design of plumbing systems	57
11.1	Drinking-water supply pipes and specifications	57
11.2	Drainpipes	58
12.	Design of plumbing systems for single dwellings	60
12.1	General considerations	60
12.2	Domestic storage tanks	61
12.3	Domestic water closets	62
12.4	Wastewater traps	63
12.5	Drains and ventilation pipes	64
12.6	Connections to the public sewer	66
13.	Design of plumbing systems for multiple dwellings	67
13.1	Domestic storage tanks	68
13.2	Control valves	68
13.3	Waste systems	68
14.	Design of plumbing systems for multi-storey buildings	71
14.1	Systems for boosting water pressure	71
14.2	Drainage systems	73
14.3	Hot water and other dual supply systems	75
14.4	Water storage vessels	77
14.5	Labelling and colour coding of non-drinking-water supply systems	79
14.6	Situations where there is a risk of cross-connection	80
14.7	Fixture unit calculations for multiple dwellings	82
15.	Design of plumbing systems for industrial and temporary applications	85
15.1	Backflow prevention in industrial, commercial and institutional water systems	85
15.2	Backflow and backsiphonage	85
15.3	Water system backflow protection devices	86

15.4	Guidance for protective devices	93
15.5	Guidance for sanitary waste systems	94
15.6	Storm water drainage systems	95
15.7	Temporary plumbing installations and connections	96
16.	Storm water drainage	98
16.1	Discharge into storm water channels or pipes	98
16.2	Combined sewers	99
16.3	Soakaways	99
16.4	Rainwater tanks	100
16.5	Rainwater intensity and roof drainage	100
17.	Intermediate and communal models for drinking-water supply and sanitation	103
17.1	Intermediate types of drinking-water supply and sanitation	103
17.2	Household water treatment	105
17.3	Communal systems for drinking-water supply and sanitation	105
18.	Conservation of water in public and domestic supply systems	107
18.1	Special problems associated with public buildings and communal accommodation	108
18.2	Leakage and wastage in the public drinking-water supply system	108
18.3	Leakage and wastage from private drinking-water supply systems	109
18.4	Use of meters to reduce wastage and excess consumption	109
18.5	Minimizing systematic excessive and wasteful use of water	110
18.6	Minimizing water usage in flushing cisterns	111
18.7	Minimizing water wastage in lawn and garden irrigation	112
18.8	Attempts to reduce water usage through intermittent supply	112
19.	Wastewater use	114
19.1	Use of greywater	114
19.2	Use of wastewater	115
19.3	Management of dual water systems	115
19.4	Identification of potable and non-potable drinking-water systems	116
	Glossary of plumbing and other terms used in the text	118
	Bibliography	123
	Contributing authors	125
	Index	126

Figures

Figure 15.1	Atmospheric vacuum breaker	86
Figure 15.2	Atmospheric vacuum breaker (normal flow and backflow conditions)	87
Figure 15.3	Double check valve assemblies	88
Figure 15.4	Pressure vacuum breaker	88
Figure 15.5	Backsiphonage illustration	89
Figure 15.6	Reduced pressure principle backflow preventer	90
Figure 15.7	Shipyards backflow contamination	91

Figure 15.8 Grease trap	91
Figure 15.9 Grease interceptor	92
Figure 15.10 Precast concrete sand and oil interceptor	92

Tables

Table 2.1 Typical volumes of fluid intake (from food and water) required for hydration	7
Table 11.1 Typical demands for various uses	58
Table 11.2 Minimum internal diameter of water pipes to plumbing fixtures	59
Table 11.3 Gradients to produce minimum and maximum velocities in drains	59
Table 14.1 Advantages and disadvantages of vacuum systems (versus gravity systems)	74
Table 14.2 Comparison of installation and operation requirements of drainage systems	74
Table 14.3 Fixture unit values for some common plumbing fixtures	83
Table 14.4 Peak water demand of plumbing fixtures	84
Table 14.5 Maximum loads for horizontal fixture branches and building drains or sewers	84
Table 16.1 Gutter slopes and roof drainage: rainfall intensity 100 mm per hour	101
Table 16.2 Roof areas drained by vertical downspouts: rainfall intensity 100 mm per hour	102
Table 16.3 Capacities of horizontal storm drains: rainfall intensity 100 mm per hour	102
Table 17.1 Service level descriptors of water in relation to hygiene	104
Table 19.1 Suitability for reuse of different grades of water	115
Table 19.2 Minimum length of colour field and size of letters	117

Case studies

Case study 1. SARS in Hong Kong	3
Case study 2. Drinking-water supply and waste removal in Dhaka	9
Case study 3. Chlordane backflow or backsiphonage	87
Case study 4. Backsiphonage from a hose	88
Case study 5. Shipyard cross-connection	90

Preface

The United Nations has declared 2005–2015 the International Decade for Action “Water for Life”, setting a world agenda that focuses increased attention on water-related issues. This initiative is of extraordinary importance in a world where preventable diseases related to water and sanitation claim the lives of about 3.1 million people a year, most of them children less than five years old. Of these, about 1.6 million people die from diarrhoeal diseases associated with lack of safe drinking-water and adequate sanitation.

By including safe drinking-water supply and sanitation in the Millennium Development Goals, the world community has acknowledged the importance of their promotion as development and health interventions and has set a series of goals and targets accordingly. Goal 7, target 10 requests the world to “halve by 2015 the proportion of people without sustainable access to safe drinking-water and basic sanitation”. The task is huge: in 2002, 1.1 billion people (two thirds of them in Asia, and 42% of the population in sub-Saharan Africa) lacked access to improved water sources. At least 2.6 billion people lacked access to improved sanitation; over half of them live in China and India. Only 31% of rural inhabitants in developing countries have access to improved sanitation, versus 73% of urban dwellers (WHO 2004b). Achieving the Millennium Development Goal drinking-water and sanitation target requires that 97 million additional people gain access to drinking-water services and 138 million additional people to sanitation annually up to 2015.

The United Nations Committee on Economic, Cultural and Social Rights has issued a statement declaring access to safe drinking-water to be a human right. The declaration reads:

“Water is fundamental to life and health. The human right to water is indispensable for leading a healthy life in human dignity. It is a prerequisite to the realization of other human rights.”

The World Plumbing Council and the World Health Organization, working within the spirit of those resolutions, present this document on health aspects of plumbing noting that sustainable health, especially for children, is not possible without access to safe drinking-water and basic sanitation facilities. This publication is dedicated to assisting in achieving the best possible plumbing levels to ensure the highest health benefits from use of sound plumbing practices. This is

especially important at a time when only 50% of the world population has access to piped drinking-water systems within the property and 31% has piped sanitation facilities connected to a public sewer system. The World Health Organization and United Nations Children's Fund statistics on drinking-water and sanitation indicate a sharp acceleration of efforts towards access to types of drinking-water and sanitation facilities requiring a considerable level of plumbing. It is thus vital that developing countries adopt or improve their plumbing practices taking into account the need to minimize the current and future risks of epidemics and diseases associated with poor plumbing.

The World Health Organization and the World Plumbing Council will feel rewarded if this document achieves its ultimate aim: to play a strategic role in facilitating the adoption of good plumbing practices in developing countries to ensure the health gains and well-being expected from such systems.

Acknowledgements

This book was produced through a partnership between the World Health Organization and the World Plumbing Council. It has been edited by Professor Charles Watson (Executive Dean of Health Sciences at Curtin University of Technology, Perth, WA, Australia) with assistance from Mary Watson (Sydney, NSW, Australia), Dale Courtman and Andy Watts (Institute of Plumbing and Heating Engineering, United Kingdom), and Robert Shepherd and Gabriella Davis (International Association of Plumbing and Mechanical Officials, Ontario, California, USA); and by Dr Joseph A. Cotruvo (Joseph Cotruvo & Associates, Environmental and Public Health Consultants, Washington, D.C., USA). A list of other contributing authors can be viewed on page 125. Professor H. Feroz Ahmed of Bangladesh University of Engineering and Technology and Sergio R. Mendonca and R. Rojas Vargas of the Pan American Center for Sanitary Engineering and Environmental Sciences (CEPIS/PAHO/WHO) are thanked for their excellent inputs. The following World Health Organization specialists provided relevant technical inputs to the development of this document: Robert Bos, Richard Carr, Bruce Gordon and Federico Properzi. Jamie Bartram (World Health Organization) provided the strategic direction throughout this process. José Hueb (World Health Organization) coordinated the technical revision and production of the document.

Abbreviations and acronyms

CDC	Centers for Disease Control and Prevention (USA)
CPVC	chlorinated polyvinylchloride
HPC	heterotrophic plate count
ISO	International Organization for Standardization
PE	polyethylene
PVC	polyvinylchloride
WHO	World Health Organization
WSP	water safety plan

1. Introduction

The objective of a public drinking-water system is to provide all consumers with a continuous sufficient supply of good quality drinking-water at an affordable price in order to ensure the health and well-being of those served. In general the traditional goal is to develop, when feasible, a system that involves abstraction of water from a source, treatment of the water, and storage and distribution of the treated water through a network of pipes, referred to as mains. The mains should pass within a reasonable distance of the private or public premises that require a drinking-water supply. Maintaining the quality of water within these distribution mains and the delivery of sufficient quantities require continuous supervision by skilled staff. Establishing and maintaining a reliable water system involves recurrent expenditures. In well-managed systems, these costs are normally borne by the consumers in proportion to the quantity of water delivered. Leakage and wastage should be controlled and minimized for safety and for economic and environmental reasons. The collection, transport, treatment and safe disposal of wastewater is also an essential element towards protection of public health.

Systems of management of the mains water system and sewerage system vary widely around the world. The waterworks and sewage disposal operating body (or bodies) may be a local authority, a government corporation or department, or a private company. In the great majority of cases, these bodies have direct responsibility for the water supplied in the mains as far as the property boundary of each individual user. It is the responsibility of the owner of each property, with the help of a competent plumber, to convey the water supply from the distribution mains into their own premises and to safely circulate it to distribution points within the buildings, and to transport liquid waste to the sewerage system. The three roles a competent plumber must assume are:

- to design, install and maintain drinking-water supply and waste removal systems;
- to manage the health and financial risks associated with plumbing;
- to help conserve limited supplies of safe drinking-water.

This publication describes the processes involved in the design, installation and maintenance of effective plumbing systems. It recommends a number of plumbing system design and installation specifications that have demonstrated their

validity from years of experience. It also examines the microbiological, chemical, physical and financial risks associated with plumbing, outlines the major risk management strategies that are used in the plumbing industry and emphasizes the importance of measures to conserve supplies of safe drinking-water.

Good design of plumbing systems is necessary to ensure that the installations are efficient and safe. Good design will also ensure that the installations are appropriate for the different circumstances they serve. The design of good plumbing services must be based on an understanding of the technical requirements and relevant regulatory restrictions.

The publication is aimed at administrators, regulators and plumbers working in areas that are served by a mains drinking-water supply or sewerage system, or are about to install a mains drinking-water supply or sewerage system. It should be of particular value to those working in countries or areas that are in the early stages of introducing effective plumbing systems. While it draws attention to the problems of drinking-water supply and waste removal in developing countries and outlines some of the strategies currently used, it does not systematically cover issues specific to developing countries. The World Health Organization (WHO) has an extensive series of publications and information sheets devoted to improving the quality of water supplies and waste removal systems in developing countries (http://www.who.int/water_sanitation_health/en/).

1.1 Ensuring water safety in production and distribution systems

The main strategy for ensuring the microbial and chemical quality of water is the implementation of a water safety plan (WSP), which incorporates a series of “multiple barriers” designed to minimize the transmission of microorganisms and other contaminants from the source of raw water to the user’s tap (see also chapter 4). Part of a WSP involves the regular use of tests to monitor the presence of certain bacteria and chemicals and to validate the performance of the system through their absence at the point of use by the consumer (see section 3.1). The primary series of barriers includes the following:

- protection of water sources from faecal and other contamination;
- storage and settling to remove some microorganisms and particulates;
- coagulation, flocculation and sedimentation to remove colloidal particles and microorganisms;
- filtration for additional microorganism and particulate removal;
- disinfection to inactivate any remaining pathogens;
- protection from recontamination after treatment and during distribution.

The operation of the WSP and the barriers is the responsibility of the water authority, but public health officials and physicians in community practice play a vital watchdog role in the identification of outbreaks that may signal a deficiency in the WSP or result from a breakdown of one of the barriers.

1.2 Removal of liquid waste

The continuous supply of adequate quantities of safe drinking-water and the prompt and safe removal of human and domestic wastes are jointly vital for health. Human and domestic waste matter from buildings and houses that is carried away through sewers is known as sewage, wastewater or liquid wastes. The system of pipes for conveyance of sewage and the respective facilities for sewage treatment are known as the sewerage system. In many cases, the sewerage system is managed by a sanitation department or part of community government other than the one responsible for drinking-water. The body that provides the wastewater management service generally funds its activities by collecting fees from its customers.

Liquid wastes are collected through a network of sewers that constitute the limit of responsibility of the management body. It is up to the owners of the properties concerned to collect the wastes within the building in which they were generated and convey them to the public sewerage system. Case study 1 is taken from the Amoy Gardens final report issued in July 2003 by an investigation conducted in part by Health Canada and WHO (WHO 2003).

CASE STUDY 1. SARS IN HONG KONG

Amoy Gardens is a private residential estate providing living space to approximately 20,000 Hong Kong residents. Around March 20, 2003, an unusual cluster of severe acute respiratory syndrome (SARS) cases was discovered in Block E of the estate with apartment units 7 and 8 mostly affected. The initial epidemiological investigation and the unusual high number of cases affecting these two units prompted the hypothesis that environmental factors may have been involved in the transmission of the infectious agent.

The areas of investigation centred on the plumbing and ventilation systems. There was a potential of plumbing and ventilation system interaction that could have promoted the transmission of an infectious agent. To prevent a free flow from the plumbing system to the indoor environment, water traps are installed to ensure waste containment. Amoy Gardens has all the necessary plumbing features for such containment. The containment would be maintained, provided that the plumbing system is operated as per design intent, with all traps sealed either by a water seal or by a solid, gas tight plug. However, if the traps were left without water and without a plug, this would establish an open path for waste, in the form of sewer gas and aerosol/droplets, to enter the occupancies. A strong vertical distribution of infectious material was obvious in unit 7 and particularly in unit 8 apartments leading to the hypothesis that unprotected occupants could have been infected by contaminated droplets drawn from a waste pipe previously used by an ill person residing in a living unit above or below, who was shedding infectious material. A transfer of particles from the water pipe system to the occupancies was tested and proven possible. The floor drain traps in many apartments seemed to have not been primed on a regular basis and thus had lost their sealing function. Thus aerosol and

droplets generated within the plumbing system had access to the bathroom through the unsealed floor drains. The inside apartment testing revealed that the bathroom fan created a vacuum inside the bathroom when the door and window were closed. This is most likely the case if an occupant uses the toilet or takes a shower. Thus infectious material could have been sucked into the bathroom from the waste stack system and exposed the occupant.

In conclusion, the environmental investigation supports an accumulation of different events that together could have mediated the epidemic in Block E of the Amoy Gardens Estate. The shedding of infectious material from several patients into the sewer system may have exceeded the critical mass needed to generate hazardous aerosols/droplets in the wastewater system. The open floor drains in combination with the overpowered exhaust fans of the bathrooms may have then sucked infectious material into the occupancies and in this way exposed people to infectious aerosols/droplets or contaminated surfaces through droplet settling.

Source: Adapted from WHO 2003.

1.3 Risk of contamination through cross-connections

Inside many properties there are, in effect, two distinct systems of pipes, one conveying drinking-water and the other wastewater. These pipes, internal and external to the building, together with the fittings themselves, are the plumbing systems of the property. The two systems of pipes pass underground to reach the building, and they come close together at sanitary fittings and fixtures such as water closets, sinks or baths. The proximity of the drinking-water supply and waste disposal systems means that there is a risk that liquid waste might contaminate the drinking-water supply system. The minimization of this risk is one of the prime objectives of a well-designed and properly built plumbing system.

Effective plumbing technologies and practices ensure that when properly applied there is no cross-connection between the drinking-water supply and the waste removal systems. The risks of cross-connection are usually greater in public, industrial and commercial premises, where dual water systems, circulating pumps, toxic wastes and other factors have to be managed. There are also risks in multi-storey buildings where booster pumps are employed to increase the mains pressure, and in special systems used in hospitals and in dental and veterinary surgeries. However, even standard single-family domestic buildings present health risks to both occupants and neighbours if faulty plumbing is installed or if plumbing is not maintained.

The ill effects of a cross-connection may not be confined to the premises concerned, but may be transferred to the mains supply system to which the plumbing is connected. In these cases, the health of a whole community may be threatened. The risks of mains contamination are greatest when the supply

pressure fluctuates or the service is intermittent. Some water supplies are intermittently shut off in the mistaken belief that this will reduce consumption. The deliberate interruption of supply is regarded as a dangerous practice, to be avoided at all costs by a well-managed water authority. However, even in a well-managed public drinking-water supply, circumstances will arise where mains must be shut off for cleaning, maintenance or repair, causing a lowered or negative pressure in the services connected to them. Pressure drops can also occur in an undersized system when large amounts of water are used in firefighting in the water system. The danger of mains contamination from pressure drops is serious and disease outbreaks in many parts of the world have been traced to this source.

The advent of technology providing for the injection of fertilizer or drench chemicals into irrigation or stock-watering systems creates another risk of contamination in both urban and rural situations. Protection against backflow, caused by backpressure or backsiphonage, along with the avoidance of all cross-connections, are essential to safeguard consumer health.

1.4 Periodic inspection

Risk minimization also depends on maintenance of equipment. In the case of large or complex systems, or where public use or the handling of food for sale is involved, the health (or other) authority may require periodic inspection and retesting as a condition for approval. The owner of any plumbing system, irrespective of its size or purpose, should be obliged to identify and to promptly repair any fault that may develop, whatever its cause.

An essential feature of risk minimization strategies is that they are regularly monitored and maintained. As part of its responsibility for protection of public health and safety, the authority must make certain that plumbing systems are assiduously maintained at the standard required in the plumbing code of practice (see chapter 7). Ensuring ongoing compliance with the code of practice through a process of periodic inspection of installations is costly, so appropriate priorities need to be set.

For systems that have the potential to pose a serious risk to public health (such as premises where food or drink is processed, hotels and lodging houses, and industrial premises) it may be a condition of the authority's approval that the plumbing system should be retested at specific intervals (such as every two years), and that such tests should be witnessed by the inspector. The inspector should also be satisfied that no cross-connections or other violations of the code have occurred since the previous inspection and test. Work completed under a system of self-certification may also be subject to periodic audit by the authority and the ability to issue future self-certification may be withdrawn in the light of any problems arising from the audit.

2. Basic principles of safe drinking-water supply

Worldwide human freshwater use increased tenfold from 1900 to 2000. Fresh water is used for domestic, recreational, irrigation, livestock support and industrial purposes. The heaviest use is for irrigation, which typically accounts for well over 60%, and industry, which accounts for a further 25%. Aquifers are being rapidly depleted and contamination is a rising threat. There are three main sources for increasing supply of fresh water where it is needed: reuse for multiple purposes, desalination of seawater and brackish (salty) surface water and groundwater, and conservation (avoiding wasteful use and water loss from leaks). Each of these is becoming essential to meet demands in an increasing number of circumstances.

2.1 Water quantity

It has been estimated that the use of at least 20 litres of drinking-water per capita per day represents the minimum quantity required for drinking, food preparation and basic personal hygiene; a quantity higher than 50 litres per capita per day should ensure basic laundry and bathing in addition to the latter uses; quantities beyond 100 litres per capita per day would represent an optimal access and should ensure all the previous uses plus a considerable level of comfort and well-being (Howard & Bartram 2003). With no access to a water source within less than a 30 minute walk to fetch water and come back, consumption is likely to be less than the basic requirement, and hygiene will probably be inadequate. It is important to note, however, that even when optimal supply is achieved, if the supply is intermittent, additional risks to health occur because of the compromised condition of the drinking-water supply, as well as interference with the function of waterborne sanitation systems.

Table 2.1 demonstrates that only a small portion of the daily water needs are required for hydration and consumed as drinking-water. Climate and physical activity, as well as personal factors, affect the daily hydration need.

2.2 Water quality and safety

At least 1.8 million people die every year from diarrhoeal diseases, including cholera; 90% are children under the age of five, mostly in developing countries. WHO estimates that 88% of diarrhoeal disease is attributed to unsafe drinking-water supply, and inadequate sanitation and hygiene. Studies have indicated that

TABLE 2.1 TYPICAL VOLUMES OF FLUID INTAKE (FROM FOOD AND WATER) REQUIRED FOR HYDRATION

Human type	Daily fluid intake required for hydration (litres)			
	Average conditions	Manual labour / high temperature	Pregnancy	Lactation
Female adult	2.2	4.5	4.8	5.5
Male adult	2.9	4.5	NA	NA
Child	1.0	4.5	NA	NA

NA: not applicable.

Source: Howard & Bartram 2003.

improved drinking-water supply reduces diarrhoea morbidity by 6% to 25%, and improved sanitation reduces it by 32%. Hygiene interventions, including education and handwashing, can achieve up to 45% reduction of diarrhoea cases. In the absence of a good-quality drinking-water supply use of household water treatment, such as chlorination with a few drops of bleach at the point of use, can reduce diarrhoea episodes by 39% (see sections 2.3.2 and 17.2) (WHO/UNICEF 2005).

2.3 Public drinking-water supplies

A drinking-water supply system consists of three major elements: source, treatment and distribution to the users. Contamination can occur in any of those segments and the prevention and mitigation of contamination are essential roles of the water supplier, as well as assuring that the water continuously delivered to the consumer's entry point is safe and aesthetically acceptable. Each element in the system has vulnerabilities to be managed. The best protection is the multiple barrier approach, which relies upon a series of barriers from the protection of the source water to multiple treatment processes and distribution system integrity to ensure that potentially harmful contaminants are removed with confidence before they reach the consumer's tap.

The prevention, mitigation and elimination of contamination risks are the key responsibilities of water providers, and regulators in their oversight role. The consuming public also has responsibilities to protect the safety of the water within their dwellings by ensuring the integrity of their piped systems, providing quick repairs when needed and properly storing and using drawn water so as to protect its quality and safety. In the event of usage of non-publicly distributed water, or when the public supply is unreliable or unsafe, users can also take measures to ensure that their water is safe to drink (see section 17.2).

2.3.1 Source water quality and protection

Ground and surface source waters are at risk of contamination from both microbes and chemicals. Chemical contamination occurs sometimes from natural origins (e.g. excess fluoride and arsenic). A water supplier must therefore first under-

stand the composition of its source water and the origin of potential contamination that it could encounter, taking into account seasonal factors. Unprotected surface source waters can receive direct contaminant discharges, as well as surface runoff potentially contaminated by human or animal sanitary wastes, agricultural waste or chemicals (e.g. pesticides runoff and automobile oil from streets). Washing and defecation in streams will be a major contributor to downstream contamination. Groundwaters are often naturally protected by soil overlays; however, some geology is porous and vulnerable to contamination from surface wastes, and also from septic tanks and privies. Unprotected and poorly designed wells and the act of drawing water from open dug wells can increase the risk of contamination.

2.3.2 Water treatment

The water treatment process should be designed to remove or inactivate microbial (bacteria, virus, protozoa), chemical (inorganic, organic) and aesthetic (undesirable taste, odour, colour, turbidity) contaminants. The most basic filtration and disinfection technologies are usually necessary and sufficient to treat surface source waters; disinfection is often sufficient for many groundwaters if they are not subjected to contamination from surface activities. Some organisms (e.g. *Cryptosporidium* protozoa) are especially resistant to disinfection, so source protection (e.g. avoiding runoff from dairy activity) and efficient filtration are necessary where they may be present. The appropriate selection, design and operation of technologies are therefore essential to ensure successful treatment of the specific source water being utilized.

Chemical disinfection processes generate some disinfection by-products that are of at least theoretical concern in some situations. However, the benefits of disinfection far outweigh those concerns, and they should not be an excuse to compromise the essential control of microbial pathogens that cause huge numbers of deaths and illness where they are not managed by the water supplier.

2.3.3 Water distribution

The conventional goal is provision of safe piped water to the taps of all consumers. There are other approaches in use, by necessity, including central standpipes, protected wells and community bottled water. A leaking distribution system increases the likelihood that even safe water leaving the source or treatment facility will become contaminated before reaching the consumer. The distribution system must be designed, managed and maintained to present a minimal level of leakage and be continuously under internal pipe pressure greater than the external hydrostatic pressure. This will ensure delivery of water with reduced losses due to leaks, and minimization of excess growth of pathogenic microorganisms. A certain level of free residual chlorine or chloramine disinfectant will reduce

the risks of recontamination within the distribution system (see also section 3.1.4). Inflows of contaminated water during distribution are major sources of waterborne pathogens and thus waterborne disease.

Case study 2, from an article in the *Guardian Weekly*, provides an example of the drinking-water supply and sewage disposal problems faced by developing world cities. In addition to the factors mentioned, water contamination also occurs in the distribution system because the pipe network is old and the supply is intermittent.

CASE STUDY 2. DRINKING-WATER SUPPLY AND WASTE REMOVAL IN DHAKA

Dhaka is built on a flood plain that has been filled in with rubbish and human waste. When the Buri Ganga River floods many areas are inundated with sewage and industrial pollution. In 2002, the population of Dhaka was 10 million, whereas thirty years before it was 250,000. One quarter of the people of Dhaka live in the most squalid slums, but they cannot legally be supplied with water from the city drinking-water supply. They are assisted by NGOs like Wateraid and Tearfund.

The city needs 1.6 billion litres of water daily to provide for basic needs but only 1.26 billion litres are actually supplied. Nearly all the water (97%) comes from deep underground sources and the water table is being rapidly lowered so the source is not sustainable. The sewage system has a nominal capacity of 120,000 cubic meters per day but the main pipe is out of service. There are many illegal connections to the sewer which discharge industrial waste including heavy metals. This means that the sewage cannot be used for fertilizer or for aquaculture.

Waterborne disease is very common and tens of thousands of children in Dhaka die from this cause each year. Much of the pollution that causes waterborne disease occurs at the household level (~70%), because water is stored in rooftop tanks which are easily contaminated.

Source: *Guardian Weekly* (John Vidal, 11–17 April 2002).

3. Hazards in drinking-water supply and waste management

3.1 Microbial risks: waterborne infectious disease

From a public health point of view, the reliable supply of safe drinking-water is vital for daily life. Unfortunately, the same water that sustains life can also be the bearer of dangerous contaminants in the form of bacteria, viruses and protozoans. These include bacteria such as toxigenic *Escherichia coli* and *Campylobacter*, viruses like *Norovirus* and *Hepatitis E*, and protozoans like *Giardia* and *Cryptosporidium*. The risk of infection and disease and the public health burden is determined by the severity of illnesses that are caused by the pathogens, the extent of the exposure, their infectivity, and the physical condition and susceptibility of the exposed population.

3.1.1 Microorganisms in water

Natural bodies of water such as lakes and rivers and groundwaters normally contain nutrients; certain microorganisms (bacteria, viruses, etc.) have evolved to take advantage of this environment. Fortunately, most of these microorganisms do not cause disease in humans, that is they are not pathogenic. In addition to microorganisms that live on nutrients in the water, still more come from runoff from soil in the vicinity. But once again, the majority of the microorganisms from soil are not harmful.

However, it is common for sewage to be discharged into these waters, without adequate treatment. Many microorganisms in sewage pose a real threat to health. Wastes from domestic and wild animals can also pose a danger. Other sources and routes of exposure may also be significant; in addition to ingestion, inhalation of aerosol droplets and contact with contaminated water can also be sources of infection (WHO 2004a).

Humans may be infected by these pathogens by drinking contaminated water or by eating uncooked shellfish that have concentrated harmful organisms they have extracted from contaminated water. Foods that have been irrigated with untreated sewage, fertilized with untreated excreta or processed with contaminated water are also an indirect source of risk. Microorganisms may seep through some soils for long distances until they reach a body of surface water or groundwater. Leaking septic tanks and inadequate latrines may contaminate nearby drinking-water sources. Some soils, such as sandstone, are effective at filtering microorganisms, but coarser and fractured soils

may allow transport of pathogenic organisms for long distances and depths.

A further cause of contamination of drinking-water is through the improper storage of water in household storage tanks and cisterns, and in smaller containers after it has been drawn. This is a common source of pathogens in drinking-water in developing countries.

3.1.2 Which microorganisms are important?

The pathogenic microorganisms from human and animal waste that are found in contaminated drinking-water include bacteria, viruses and protozoans, and many of the illnesses that they cause can be fatal. Some of the important water-borne pathogenic bacteria include several salmonellae organisms such as the typhoid bacterium, *Vibrio cholerae* bacillus, *Shigella* spp., pathogenic and enterohaemorrhagic *E. coli*, and *Yersinia enterocolitica*. Some notable pathogenic viruses in water include *Hepatitis A* and *Hepatitis E* virus, *Norovirus*, *Sapovirus* and *Rotavirus*. Notable pathogenic protozoans in water include *Giardia intestinalis*, *Entamoeba histolytica* (the cause of amoebiasis), and *Cryptosporidium parvum*. Some helminthes that cause disease from water contact include *Dracunculus medinensis* and *Schistosoma* spp.

3.1.3 Estimating levels of water quality and sewage contamination

The WHO Guidelines for Drinking-water Quality focus on *E. coli* (preferred) and thermotolerant coliform bacteria, which are present in large quantities in the intestines of warm-blooded animals, as the best indicators of the sanitary quality of water supplies. However, they alone are not necessarily sufficient indicators for viruses and protozoa. *E. coli* are relatively easily disinfected, but viruses and protozoa are usually much more resistant to chlorine and (especially) chloramines. The latter are in fact weak disinfectants. *E. coli* are well known to public health and plumbing professionals as a sign of recent contamination of water with human or animal waste. Analysis by culture methods may require 24 to 48 hours per test. *E. coli* normally only survive in water for a few days, so measuring levels of *E. coli* under standard conditions is a way of estimating the level of recent human or animal faecal contamination. Total coliform bacteria measurements are used in some countries as conservative indicators of the sanitary condition of the drinking-water; however, they are not direct indicators of sanitary contamination, especially in tropical countries, where many bacteria of no sanitary significance occur in almost all untreated supplies.

3.1.4 Microbial growth in plumbing: heterotrophs, *Legionella* and *Pseudomonas*

Heterotrophs

Microorganisms grow in drinking-water distribution systems, especially in the absence of a residual disinfectant. Most of these are heterotrophs that require an external source of carbon, and they grow in water, on particulates and on

surfaces in contact with water as biofilms, and also on foods. They can also include a broad spectrum of opportunistic pathogen microorganisms such as *Aeromonas*, *Flavobacterium*, *Serratia*, *Pseudomonas* and *Klebsiella*, but there is no evidence in the general public of an association of any of these organisms with gastrointestinal infection through ingestion of drinking-water (WHO 2004a); there may be concerns with some severely immunocompromised persons and hospital environments (Bartram et al. 2003). They are found in all waters without residual disinfectant, including bottled waters, and on carbon filters and other treatment devices and surfaces. Most heterotrophs are not harmful to healthy persons, but they can be a nuisance by generating tastes and odours or discoloration of water supplies. The principal determinants of growth of heterotrophs are lack of disinfectant residual, warm temperature, availability of nutrients including organic carbon, and stagnation. They are measured by aggregate heterotrophic plate count (HPC) tests that detect a wide range of organisms, including many bacteria and fungi. High counts are more likely to be indicative of biofilms and lack of cleanliness in the system and availability of nutrients. In the absence of indicators of sanitary significance (e.g. *E. coli*), HPC organisms in themselves are not indicative of faecal contamination.

Legionella

Legionella are among the exceptions to harmless growth organisms in distributed water, and they are not measured by HPC tests. *Legionella* can grow to significant numbers in warm waters, hot water heaters, hot tubs, hot water lines and shower heads, and probably in the plumbing systems of large buildings, and in cooling towers for air conditioner heat exchangers. Special precautions are required to prevent and control *Legionella* in hospitals and health care facilities, because aerosols from showers, spas and cooling systems are a route of infection and those facilities contain high-risk populations. *Legionella* grow well in water at temperatures in the range of about 25 °C to 50 °C. Preventive and remedial controls are essential, especially in hospitals and health care facilities (Surman-Lee 2006). The WHO Guidelines for Drinking-water Quality indicates that the water temperature should be maintained outside the range of 25–50 °C, at which *Legionella* proliferates (WHO 2004a); however, hot water temperatures above 50 °C may also present a scalding risk to young children and the elderly (see section 3.3).

Pseudomonas aeruginosa

Pseudomonas aeruginosa microorganisms also grow in piped plumbing and distribution systems and on devices under the conditions cited above. They can cause a range of infections but rarely cause serious illness in healthy individuals. They are a significant problem in hospital environments where the organism can colonize damaged sites such as burn and surgical wounds, the respiratory tracts

of susceptible people and physically damaged eyes, and they have caused skin infections in hot tubs and spas. Cleaning of contact lenses with contaminated solution can cause a type of keratitis. Ingestion of drinking-water is not an important source of infection (WHO 2004a).

3.2 Chemical risks

Since the end of the 19th century the main health focus for drinking-water supply has been on microbial risks. Microbial contamination remains the most significant, imminent and large-scale manageable risk associated with drinking-water when water is not properly managed. Chemical contamination of drinking-water can result from natural or human-related contamination of surface water or groundwater, or contamination that occurs during the treatment of water (disinfection by-products), or delivery through mains or household water (corrosion).

The number of potentially harmful chemical contaminants (if present at sufficient concentrations) identified in drinking-water in small amounts has been increasing rapidly over the last twenty years due to the development of analytical methods capable of detecting levels in parts per billion and parts per trillion. These chemicals are usually present at extremely low concentrations when detected. Water is just one source and usually not the most important source of exposure to most of these chemicals, except for disinfection by-products. A few of these contaminants have been shown to cause adverse effects in humans when ingested via highly contaminated water. Some of the more common contaminants detected, with their mode of occurrence and health effects under some exposure conditions, are: arsenic (natural; cancer), fluoride (natural; dental and crippling skeletal fluorosis), lead (corrosion of lead pipe; neurological effects), pesticides (agricultural use and spills; variable effects), nitrate and nitrite (agricultural and sewage; infant deaths), radon (natural geology to indoor air and some groundwaters; cancers), sulfates (natural; causing temporary diarrhoea to non-residents). Arsenic, fluoride and nitrate/nitrite are probably the most important examples that have shown demonstrable health effects from consumption of contaminated water.

Some groups, including young children and the immunocompromised, may have higher than average risk of the effects of some chemical exposures in the environment compared to the general population. Examples include the effect of aluminium on dialysis patients when inadequately treated dialysis water is used; the impact of lead poisoning on pregnant women and infants, usually as a result of exposure to lead paint dust; and the effects of arsenic on people with compromised nutritional status.

Arsenic is widely distributed in small quantities in waters around the world. However, thirty years ago in Bangladesh millions of shallow surface wells were drilled to reduce the risk of gastrointestinal diseases from highly polluted

surface water. Unfortunately, the groundwater from many of these shallow tube wells was contaminated with arsenic and this was not determined before the wells were put into service. It has been estimated that over 40 million people in Bangladesh are exposed to potentially risky levels of arsenic in water. The WHO guideline value for arsenic is 10 parts per billion; however, some countries use 50 parts per billion as an interim goal due the difficulty and cost of removing arsenic from drinking-water.

Fluoride is another natural water component that has caused serious consequences when it is present in excessive amounts. At recommended values it has beneficial effects by reducing tooth decay (guideline value is 1.5 milligrams per litre, but national regulators should also take into account climatic conditions, fluoride intake from other sources and total water consumed). At slightly higher consumption levels fluoride can cause discoloration of tooth enamel, and at even higher levels (greater than about 14 milligrams per day) serious adverse skeletal effects occur.

Nitrate and **nitrite** in excess are a particular risk to infants, causing methaemoglobinaemia, which may result in morbidity and death from short exposures. The WHO guidelines are 50 milligrams per litre for nitrate and 3 milligrams per litre for nitrite, and the sum of the ratios of each to its guideline value should not exceed 1 (WHO 2004a). Nitrate and nitrite are usually present in water contaminated with sewage, septic tank effluent or agricultural runoff. Combined exposure to nitrate or nitrite and gastrointestinal disease-causing microorganisms seems to cause the greatest risk of methaemoglobinaemia.

Epidemiological studies of environmental contaminants are usually driven by concerns arising from episodes of exposure or evidence of chronic exposure. However, attempts to understand the epidemiology of chemical contamination of drinking-water reveal a number of complex issues that make such studies difficult to carry out. These issues include:

- the fact that drinking-water is seldom the principal source of exposure, except for arsenic and fluoride in some cases;
- the wide variation in the amount of contamination from non-drinking-water sources;
- difficulty in measuring dietary concentrations;
- difficulty in accurately defining the duration and magnitude of human exposure;
- the relative impact of other factors besides chemicals that may contribute to similar health risks.

A poor assessment of relative risks sometimes makes it difficult for officials to make good public health decisions. They should rely on recognized national and international health authorities and make use of solid background information

such as the WHO Guidelines for Drinking-water Quality as guides for these matters (WHO 2004a).

Drinking-water is drawn from an environment that changes constantly as a community develops. Therefore, it is increasingly important that there is constant awareness of developing sources of potential contamination from industry, waste disposal or agricultural practices, or changes in urbanization patterns. Medical authorities, environmental epidemiologists, toxicologists, chemists, engineers and exposure analysts need to effectively communicate and work collaboratively to help risk managers determine which environmental hazards are real, to help regulators make sensible and realistic standards and to help policy-makers make the best environmental policy and water management decisions. The WHO Guidelines for Drinking-water Quality provide comprehensive and up-to-date guidance to decision-makers by providing consensus recommendations developed by international experts from all of those disciplines.

3.3 Other risks

3.3.1 Hot water and scalding

Burns from hot tap water can result in severe injuries to young children and the elderly. Almost all hot water burns in children occur in the bathroom. The average temperature of hot water systems in Australia is 65 °C. Water at this temperature can inflict a severe burn on a child in less than half a second. In many industrialized countries, the average hot water temperature is 60 °C, which will cause a severe burn in about five seconds.

While parents can help reduce the risk by checking bath temperatures and by supervising children, the obvious answer is to minimize the risk by reducing the temperature of the water in the hot water system to below 55 °C (but not below 50 °C, which would increase *Legionella* risk), depending on the specifications of the system that has been installed. An alternative is to install thermostatically controlled mixing valves on the bath taps. Other alternative strategies to prevent accidents with children are the installation of a child-resistant hot water tap (with a push and turn movement similar to that used in the caps of medicine bottles) or the provision of a childproof tap cover. Tap covers are only suitable for certain kinds of taps.

Whenever any maintenance or scheduled work is carried out overnight, procedures must be in place to ensure that occupants are notified and aware of the dangers. There have been instances when pasteurization (temporarily raising the temperature of the hot water system above normal levels) in homes for the aged has had fatal consequences. The Institute of Plumbing and Heating Engineering in the United Kingdom of Great Britain and Northern Ireland recommends maximum outlet temperatures as follows: bidet 38 °C; shower 41 °C;

washbasin 41 °C; bath 44 °C; and supervised bath 46 °C (see sections 3.1.4 and 14.3.1) (IPHE 2005).

Some plumbers have argued that reducing water temperature is not a simple matter. The following potential disadvantages must be taken into account:

- The cost of storage of larger quantities of lower temperature hot water may be higher than that of smaller quantities of hotter water.
- The water may not be hot enough for other purposes, such as washing kitchen dishes.
- Storage of tepid water may introduce a risk of bacterial growth (*Legionella*, *Mycobacterium avium* and *Pseudomonas aeruginosa*).

The ideal solution is to maintain a reservoir of relatively hot water, but to ensure that high-temperature water cannot be accessed in shower or bath taps. This can be done with a thermostatically controlled mixing valve at the bath or shower.

3.3.2 Damage to buildings and land

Flowing water can exert significant force and under some circumstances this force can result in damage to buildings and to land. Plumbers should be aware of the potential damage to building structures that can be caused by water hammer. Installation of water hammer arresters and antioscillation valves will reduce this risk. Damage to foundations and other structures can be caused by uncontrolled water and wastewater runoff.

3.3.3 Corrosion

All water is corrosive in some circumstances, but excessive corrosion is a serious economic and potential health problem. It may lead to structural failures and deterioration of chemical and microbiological quality, including exceedance of guideline values for lead, copper and iron. Corrosion is partial dissolution of any (especially metal) materials in the plumbing system. It can be caused by interactive water quality factors including pH, insufficient or excess alkalinity, temperature and galvanic action. Corrective actions are sometimes complex and may involve management of calcium, carbonate and bicarbonate, dissolved oxygen, and especially maintaining the appropriate pH, which should usually be in the approximate range of 7 to 8.5 to minimize corrosion.

3.3.4 Incrustation

Water containing excessive amounts of bicarbonates, carbonates or iron has a tendency to deposit minerals on the pipe surface. These minerals are solid and difficult to remove without mechanical cleaning, which is costly. This mineral deposition reduces the internal volume of the pipe and thus reduces the flow

capacity; sometimes this leads to total blockage. In addition, this irregular surface can become a locus for biofilms and can harbour microorganisms, shielding them from contact with disinfectant. It can also cause excessive disinfectant demand.

4. Water safety plans in the operation and management of water systems

The safety and performance of a system for providing drinking-water depends upon the design, management and operation of the three principal components: source, treatment and distribution. If contamination has occurred and it is not controlled before it reaches the consumers' taps, illness or even death is possible. The system must therefore be designed to cope with all of the problems that could occur, and proper performance of the entire system must be ensured at all times. The most effective way to consistently ensure the safety of a drinking-water supply is through the use of a comprehensive risk assessment and risk management approach that encompasses all of the steps in the drinking-water supply train from the catchment to the consumer. WHO has developed a systematized water safety plan (WSP) approach based upon worldwide experiences of success in managing drinking-water quality (WHO 2004a). The WSP concept draws upon principles and concepts of prevention, multiple barriers and quality management systems such as hazard assessment critical control points (HACCP) as used in the food industry.

A WSP has three key components guided by health-based targets (drinking-water standards and guidelines and codes), and overseen through surveillance of every significant aspect of the drinking-water system. The concept and methodology can also be adapted to sewage management systems. The three components are:

- **System assessment** to determine whether the system as a whole (from source to consumer) can consistently deliver water that meets health-based targets. This includes assessment of design criteria for new systems as well as modifications.
- **Measures** to monitor and control identified risks (and deficiencies) and ensure that health-based targets are met. For each control measure, appropriate operational monitoring should be defined and instituted that will rapidly detect deviations.
- **Management plans** describing actions to be taken during normal operations or incident conditions, and documenting the system assessment (including system upgrades and improvements), monitoring, and communication plans and supporting programmes.

The primary objectives of a WSP are the minimization of contamination of source waters, reduction or removal of contamination through appropriate treatment processes, and prevention of contamination during processing, distribution and storage. These objectives are equally applicable to and can be tailored to large piped supplies and small community supplies, large facilities (hotels and hospitals) and even household systems.

The objectives are met through the systematic and documented planned methodology for the entire life of the system. A progression of the key steps in developing a WSP is as follows:

- assemble and train the team to prepare the WSP;
- document and describe the system;
- undertake a detailed hazard assessment and risk characterization to identify and understand how hazards can enter the system;
- assess the existing proposed system (including a description of the system and a flow diagram);
- identify control measures – the specific means by which specific hazards may be controlled;
- define monitoring of the control measures – what are the limits that define acceptable performance and how are these monitored;
- establish procedures to verify that the WSP is functioning effectively and will meet the health-based targets;
- develop supporting programmes, for example training, hygiene practices, standard operating procedures, upgrades and improvements, research and development;
- develop management procedures, including corrective actions for normal and incident conditions;
- establish documentation and communication procedures.

These key steps in the WSP operate in a continuous and cyclical mode by returning to the documenting and system description step and repeating the process routinely. Detailed expansions of this WSP concept can be found in the Guidelines for Drinking-water Quality (WHO 2004a) and in other writings including detailed discussions of WSPs for distribution systems (Stevens et al. 2004).

5. The role of plumbers in risk assessment and risk management

The supply of safe water and the removal of human waste are vital for health and well-being. The main aim of plumbing systems is to collect, transport and distribute water to individuals in a community, and to remove liquid waste. Unfortunately, all of these beneficial processes incur risks. These risks include contamination of water sources with bacteria, accidental cross-connection of drinking-water supply and waste removal systems, and chemical contamination from corrosion of pipes and other fittings. Thus, the second aim of plumbing systems must therefore be to manage risk.

Risk management uses a variety of different strategies. First of all, risks must be recognized, analysed and evaluated. Then the risks are minimized by a number of means, the most fundamental being system design and construction or assembly using appropriate techniques and materials. A fundamental requirement is the use of quality assurance systems to ensure that plumbers are well trained and that they adhere to a code of good practice. Some risks cannot be eliminated and the resultant financial risk must be either accepted by the plumber or transferred by means of insurance.

Plumbers are trained to design, install and maintain plumbing systems. However, the work of plumbers goes beyond the provision of plumbing systems; they must manage the risks associated with plumbing installations. They share this risk management role with public health officials. Finally, in a world that is now increasingly aware of the value of natural resources, plumbers and other plumbing professionals play a vital role in water conservation.

5.1 Risk recognition

Risk recognition is based on a comprehensive understanding of all potential hazards that may arise in establishing and maintaining a plumbing system. For example, the Romans recognized the undesirability of contamination of water from soil and human and animal waste and they built aqueduct systems to deliver clean upland water to their cities, and sometimes used lead pipes. The Latin word for lead (plumbum) gave rise to the common name for the plumbing profession. It has taken almost two thousand years to recognize the risks associated with lead pipes and corrosive water, and lead use was discontinued in drinking-water systems relatively recently. The history of lead use is an important reminder that new technologies will often bring new and unexpected risks.

Constant vigilance and research are necessary to uncover these new risks as they arise and to rapidly correct them.

5.2 Risk evaluation and analysis

Once a risk has been identified, the nature of the risk must be analysed and its relative importance needs to be evaluated. The analysis of the risk should reveal what causes the risk; the evaluation of the risk in its context will enable a judgment to be made about what action to take. In some cases, a risk might be identified but assessed to be very low in importance and costly to eliminate. In this case, the evaluation might lead a community to accept the risk and simply monitor the problem. On the other hand, the evaluation of another risk might demand urgent action to protect the community.

5.3 Risk abatement

Once a risk has been recognized and evaluated as being important, steps must be taken to minimize the risk. Risk abatement is the main strategy for managing risk in the domain of plumbing. Plumbing risks can be prevented and minimized by education and training and by the adoption of quality assurance systems such as codes of best practice. Many countries enforce these codes of best practice by establishing laws and regulations that demand certain standards of practice. For example, modern codes of practice prohibit the use of certain dangerous materials, such as lead, in pipes that supply water for human use. Risk abatement strategies are only effective if their application is assiduously maintained. Risk abatement in plumbing requires both the community and individuals to make a major continuing investment in time and money to prevent risks, and to minimize risk once discovered.

5.4 Risk acceptance and risk transfer

Because it is impossible to identify and eliminate every possible risk, plumbers must face the possibility that even with good standards of practice there will be occasions when some problem with a plumbing installation will occur. In some of these situations people may be made ill or injured and the plumber may be held responsible. There are three possible ways to deal with these kinds of circumstances. The first and normally the best ethical approach is to accept responsibility and rectify the problem. The second is risk acceptance – the plumber is confident that the risk is very low and makes an informed judgment not to correct it. In this case the impact of being wrong would be financially catastrophic because of legal liability. In the third option, then, the plumber can transfer the financial risk to an insurer by paying an annual fee. Although this practice is possible in developed countries it might be less feasible in many developing countries.

Regulation of plumbing technology and practice is intended to minimize public as well as private health risks. The main instrument of regulation is the development and implementation of good practice guidelines, commonly called a code of practice. There is no doubt that the implementation of a well-designed plumbing code of practice will assist those who design plumbing systems and the plumbers themselves, and help to protect the public.

6. Principles of effective plumbing systems

This chapter summarizes the aims and objectives of a good local plumbing system – that is, the drinking-water supply that serves a building and the system for liquid waste removal that connects the building to the sewer mains. The system should be operating within a context of standards and codes, determined and overseen by qualified public authorities, that specify the requirements for its design, composition and management, and the training and practices of the plumbers and operators who build and maintain it. In places where these principles are not currently attainable, they should be regarded as high-priority goals to be achieved when circumstances permit, and positive steps should be taken to achieve those goals. They are based upon the need to preserve the health, safety and well-being of the people served by a plumbing system. Efforts should be made to promote public awareness of the benefits of quality plumbing and the dangers of an improperly installed plumbing system.

The three chief aims of a good plumbing system are to supply safe drinking-water in adequate quantities, to remove liquid wastes efficiently, and to minimize risk of failure through vigilance and quality assurance. Each of these chief aims includes a number of subsidiary objectives, which are described in this chapter.

6.1 Water supply goals

The goal for every community or group of homes should be for a piped central source of good-quality water for all domestic uses. In addition, with a piped drinking-water supply, proper sanitary transport and waste treatment and disposal facilities are important to ensure a safe domestic and community environment. There are costs both in the initial construction and maintenance of these facilities, and sustainability requires provisions for finance, operation and maintenance.

6.1.1 The local drinking-water supply should be adequate in terms of quantity, safety, continuity and reliability

The quality of the water provided through public mains is the responsibility of the drinking-water supply authority. It should be continuous and pressured at all times, and it should meet national standards or WHO drinking-water guidelines at the consumers' taps. The distribution system should not be affected by excessive leakage and it should be constructed of appropriate materials.

6.1.2 Water supplied for human consumption should be safe at all times

Plumbing systems in domestic or commercial premises should not be permitted to degrade the mains water in any way. The drinking-water supply must be protected from cross-connections with unsafe sources or with wastewater plumbing systems. It must be able to cope with the hazards of backpressure or backsiphonage, and the water should not be in contact with plumbing materials that might impart contamination. Those materials should meet quality and performance specifications determined by the authorities, or by an accepted certification organization.

6.1.3 Every building should have an internal drinking-water piped system

An adequate piped supply provides safe access to water for domestic needs. It obviates the need for the dedication of time and effort to transport of water, and reduces the risk of contamination during collection, transport and storage. Ready access to sufficient safe water within the home improves personal hygiene and facilitates safe management and disposal of sanitary waste. The quality and quantity of the drinking-water supply within the home not only has a profound effect on the health of the householders, but also contributes to the comfort and enjoyment of their lives and those of the community. Interim measures, based on public standpipes and communal facilities, are effective but they should be regarded as an intermediate stage towards the realization of these principles.

6.1.4 Water should be conserved by minimizing leakage and wastage

Piping systems and plumbing fixtures should be so designed, maintained and used as to minimize leakage and wastage. Leakage can also be avoided by sound installation practices and protection of pipes and fixtures against corrosion and accidental damage, including that caused by freezing. Quickly repairing leaking faucets is an important practice. Wastage can also be minimized by proper education on the need for rational use of drinking-water.

6.1.5 Water should be supplied from a suitable number of accessible and hygienic fixtures

Ideally, every self-contained family dwelling should have, as a minimum, one water closet, one washbasin, one kitchen sink and one bathtub or shower, and provision for laundry facilities. Other buildings, whether used for habitation or other purposes, should be provided with an adequate number of fixtures in accordance with their respective needs. All plumbing fixtures should be made of durable, smooth, non-absorbent and corrosion-resistant material, so designed as to be fit for the purpose and easily cleaned, free from concealed surfaces that could become fouled, and incapable of contaminating the mains drinking-water supply by backsiphonage. They should be located and spaced so that they are accessible for the intended use and for cleaning. Walls and other surfaces that may become accidentally fouled

during the use of the fixture should be impervious to water and accessible for cleaning.

6.1.6 Building contents should be protected from the effects of malfunctioning of the plumbing system

Precautions should be taken against damage to the property, or danger to the health of its occupants, in the event of malfunctioning of the system. Fixtures should be provided with adequate overflow capacity. Roof tanks and other hidden elements of the system should be similarly provided with overflows that discharge in such a way as to act as a warning before causing damage. Every pressure vessel that is part of the system should be equipped with a temperature and pressure relief valve. Food preparation and storage rooms within the building should be located so that any leakage or backflow in the drainage system cannot contaminate their area or contents. In the case of industrial or commercial premises where food is processed or prepared, or where sterile goods or similarly susceptible materials are stored or handled, additional precautions should be taken by indirect connections of the internal fixtures to the plumbing system.

6.1.7 Adequate lighting and ventilation should be provided for toilet and washing fixtures

Rooms where water closets, toilets, urinals or other similar fixtures are located should be properly lighted and ventilated. No such fixture should be allowed in a room used for living, working, food preparation or other such purposes. Industrial or commercial premises or public buildings containing rooms where food and drinks or other material for human consumption are served, handled, stored or prepared should not have a water closet or urinal open directly from such a room, but should be separated by an adequately ventilated lobby or passage. Other fixtures, such as sinks, washbasins and baths, should be located so that lighting and ventilation are adequate to ensure their safe and hygienic use.

6.1.8 Hot water systems should be carefully designed to avoid health hazards

Equipment for heating and storing heated water should be designed and installed in ventilated areas to guard against dangers from explosion or overheating. Pipes used for the conveyance of hot water should be made of materials suitable to withstand the temperature of their contents, and water temperatures should be maintained at the specified level.

6.2 Liquid waste disposal goals

6.2.1 Liquid wastes should be disposed of promptly and hygienically

Every fixture, including a wall-mounted tap, should have drainage facilities to prevent the accumulation of wastewater and spillage, even though this may be

uncontaminated. Wastes should be removed rapidly from each fixture by a system of drainpipes that will prevent any further human contact. When a public sewer exists within reasonable distance of the premises the building waste system should drain to that sewer. Where no such sewer exists, disposal should be through an approved method of treatment, such as to a septic tank, where soils and population densities permit, that is located so as to cause no nuisance to the occupants of the building or to those of neighbouring properties. Where chemical closets are used, adequate arrangements must be made for sanitary disposal of wastewater (such as the wastewater from other fixtures, sinks or baths), as well as the residue from the chemical closet.

6.2.2 Drainage systems should be of adequate size and easily cleaned

Drains should be of adequate capacity and should be designed, constructed and maintained to convey wastewater rapidly from the building without fouling, depositing solids or clogging. They should be furnished with adequate, easily accessible clean-outs or access chambers (manholes) arranged so that the pipes can be readily cleaned.

6.2.3 Drainage systems should be equipped with liquid seal traps

Each fixture, or group of fixtures, connected to the drainage system should be equipped with a liquid seal trap. The depth of liquid in each seal must be adequate to prevent the emission of odours and gases, and must prevent access by insects or rodents from the sewer to the premises. Self-sealing waste valves are a possible alternative to liquid seal traps in some situations.

6.2.4 All drains should be adequately ventilated

Every drainage system should be designed and constructed so that adequate quantities of air can circulate through every pipe, thus enabling the system to function properly and protecting the liquid seal of the traps. The uppermost part of the drainage system should be connected to a ventilating pipe of adequate size, discharging above roof level and positioned so that the return of foul air to the building is prevented. Air admittance valves are a possible alternative when positive pressure is not required. The valves open automatically on sensing negative pressure within the system, allowing air ingress only.

6.2.5 Deleterious substances should be excluded from sewers

Precautions should be taken to exclude from the drainage system any substance that may clog or increase the likelihood of clogging of pipes, produce explosive mixtures, corrode or otherwise damage pipes or their joints, or interfere with the functioning of sewage treatment plants or not be removable by them, thus contaminating receiving waters. Substances that can endanger those who work on

the public sewerage system must also be excluded. Pretreatment requirements and other controls should be imposed on industrial and non-domestic dischargers so that they use suitable disposal methods for those wastes.

6.2.6 Backflow of sewage should be prevented

Drainage systems should be designed and constructed so that sewage cannot enter buildings connected to the sewerage system in the event of backflow from the public sewers due to flood, blockage or any other cause.

6.3 Plumbing goals

6.3.1 Plumbing materials and workmanship should conform to accepted quality standards

Pipes, joints, fixtures and other elements of a plumbing system should conform to accepted quality and performance standards, and should be sufficiently durable to give satisfactory service over a long period. Indications of conformance with standards is often marked on the product. These standards should be specified or adopted from existing standards by appropriate authorities. Only those persons who have been properly trained and have given evidence of their competence should be responsible for the selection and installation of plumbing systems.

6.3.2 Plumbing installations should be tested and disinfected before being put into service

Tests suitable for various types and designs of plumbing systems should be specified by the water, sewerage and other authorities concerned, and no system should be put into service until such tests have been satisfactorily completed (see section 7.4).

6.3.3 Adequate training should be provided for plumbing professionals and the public should be made aware of the dangers of poor plumbing

It is imperative that individuals installing and monitoring plumbing systems have access to adequate continuing education and training. An accreditation system should be developed to ensure that all such individuals have achieved and demonstrated appropriate levels of competency.

6.3.4 Plumbing systems should be properly maintained

Risk avoidance and minimization depend on the effectiveness of maintenance of equipment and facilities. For large or complex systems, or where public use or the handling of food for sale is involved, the public health (or other) authority may require periodic inspection and retesting as a condition for approval. The owner of any plumbing system, irrespective of its size or purpose, should be obligated to identify and to promptly have repaired any fault that may develop, whatever its cause.

7. Codes of practice for plumbing

A code of practice is intended to ensure the quality and functionality of plumbing systems and to protect the health of the occupants of the premises where a plumbing system is to be installed, as well as the health of the public in general. National codes of practice are often designed to cover all the states, territories or provinces in that country, and their content applies to all plumbing proposals. In some instances, the national code may only cover technical specifications and local authorities may need separate by-laws or regulations to regulate administrative matters for connection to the authority's water, sewerage or drainage systems.

Quality assurance is a major strategy for risk minimization in the supply of water and disposal of wastewater. A major component of quality assurance programmes in plumbing is the use of codes of good practice that specify the requirements to be met to assure conformance with norms. These codes are usually supported by legislation or by local government regulations and are therefore referred to as codes of practice or mandatory codes of practice. In some countries, the term “ordinance” is used to describe them. The term “code of practice” is used in this document.

Codes of practice attempt to minimize risk by specifying technical standards of design, materials, workmanship and maintenance for plumbing systems. Some model text having particular health significance and a sample model plumbing code of practice (ordinance) is provided in section 7.1. Citations to other codes are also provided for reference.

The primary aims of a plumbing code of practice are to ensure the following:

- that planners, administrators and plumbers develop the required competency so these codes are respected and applied;
- that standards are set to ensure that plumbing assemblies, materials and technologies are safe and effective;
- that plumbing installations meet these standards;
- that plumbing installations are maintained to ensure continuous safety and effectiveness.

The economic, geographic, demographic and cultural circumstances relating to plumbing needs vary from country to country and from region to region. The plumbing code of practice for any given community must take these variations into account and specify minimum standards accordingly.

The responsibility for overseeing the implementation of the code of practice is awarded to a designated authority such as a national or state government department or a local government organization. The designated authority must have the requisite competence, and the power and responsibility to enforce compliance within its area of jurisdiction. The essential feature of the authority is that responsibility and power of implementation are vested in a single identifiable body, whose responsibilities and authority are clearly defined in the plumbing code of practice. The concept of undivided responsibility for enforcing the code of practice is particularly important since there may be numerous authorities that have specific roles and requirements linked to plumbing systems. They may include water and sewerage authorities, health departments, building (including plumbing) code officials, food and drug officials, and bodies that deal with environment, tourism, housing, industry and transportation. Plumbing codes of practice should address the unique requirements of each of these different bodies so that a building owner, builder or plumber need only deal with a single authority.

One of the most effective ways to establish standards and ensure compliance is through a national plumbing code of practice that is enforced by a national government department or ministry. This national authority may in turn delegate its powers to state, provincial or local governments. In this way, a set of all-inclusive national standards and regulations can be adopted in whole or in part to suit the specific requirements of the particular jurisdiction. It is not always necessary to develop de novo a code or standards since many models are available; however, it will usually be necessary to adapt a chosen code to local conditions. Some examples of local variations could include piping materials to suit local corrosive water conditions, or the depth of buried piping required to prevent freezing.

In some areas, the local authority may establish committees to advise it on matters dealing with the administration of the plumbing code. This could be in the form of a plumbing board to deal with the qualifications and licensing of plumbers, and a committee to deal with technical issues in the code of practice. These committees would ideally include design engineers, installation contractors and labour representatives.

A typical plumbing code of practice will grant the following powers to the authority charged with enforcing compliance:

- the right to register and license plumbers to specified qualifications;
- the right of entry to facilities for the purpose of making inspections;
- the establishment of procedures and conditions under which permits for plumbing installations may be granted;
- the right to charge fees for granting plumbing licences and permits, in accordance with an approved scale;
- the right to take administrative actions and actions in the courts of law in the event of violations.

The success of newly adopted plumbing codes of practice and associated regulations depends to a significant extent on acceptance by the public. Education programmes may be needed to inform the public of the health and safety benefits of regulated plumbing installations and the dangers of non-compliance.

The formulation of a plumbing code of practice is a demanding task. However, most of the challenges have already been addressed in the preparation of codes of practice in countries and cities around the world, and many of these codes have stood the test of time. Many codes emphasize the aims and roles of a code of practice in the form of a preamble or the presentation of general principles, which sets the scene for the regulations that follow.

7.1 A sample model code of practice

This section offers some model text taken from existing codes of practice as illustrations to assist those preparing a code of practice. A typical introductory statement could be as follows:

The following standards and regulations for plumbing systems were prepared under the authority of paragraph XXX [page YYY] of the plumbing code of practice number ZZZ dated AAA and adopted by the Authority or Town Council of MMM, being the authority having jurisdiction, at its meeting on BBB.

The following is a sample code of practice that designates the town council (or other authority) of the municipality as the authority having jurisdiction over plumbing in its area:

1. The town council of the municipality (referred to here as “the authority”) is hereby designated as the authority having jurisdiction over all plumbing systems within the boundaries served by the public drinking-water supply system of the municipality.
2. For the purposes of this Code of Practice the words “plumbing systems” shall be taken to mean all water pipes, drains, sanitary fixtures and other installations, whether within or outside buildings, connected or capable of being connected in the future, directly or indirectly, to a public water main or to a public sewer, irrespective of whether these plumbing systems are publicly or privately owned.
3. The authority shall specify standards and regulations as it considers necessary to ensure that all plumbing systems within its jurisdiction are designed, installed and maintained in accordance with accepted sanitary principles. These standards and regulations shall comprise the “plumbing code of practice” of the municipality, that is referred to here as “the code”.
4. The authority shall administer the code, for which purpose it shall engage such staff or assistance as is necessary and shall take such actions as may be necessary and reasonable to obtain compliance with its provisions, as regards both

plumbing systems already existing within its area and those to be installed at any time in the future.

5. No person shall construct, install, extend or materially alter any plumbing system without making formal application to, and receiving formal approval from, the authority. Contravention of the code will be sufficient grounds for approval to be withheld.
6. The authority shall maintain a register of persons qualified under the regulations of the examining board of the national association of plumbers who have applied to have their names entered. The authority may grant a licence, at its discretion, to anyone so registered to become a “licensed plumber”, after it is satisfied that such person is capable, of good repute, and familiar with the provisions of the code. Licences of a grade commensurate with the applicant’s qualifications and experience shall be granted for a fixed period of years, after which they may be renewed after reapplication, but the authority shall have the power to revoke or terminate a licence in the event of unsatisfactory work or deliberate breach of the provisions of the code. In the event of a dispute regarding the issuing, renewal or termination of a plumber’s licence, such dispute may be referred to an arbitrator, nominated by the authority or incumbent president of the national association of plumbers and acceptable to both parties, whose decision shall be binding.
7. Except where the authority shall agree in writing to other dispositions, only a licensed plumber shall be authorized to be responsible for the construction, repair, alteration or removal of pipes, valves, drains or other appurtenances of any drinking-water supply or drainage system (including storm drainage discharging into a public sewer or watercourse) in any building or on any land. Only a licensed plumber may make a connection to a public water main or to a public sewer, and he shall be responsible for giving notice to the water and sewerage authorities of the intention of making such connection for satisfying any requirements of those bodies.
8. The authority may require any plumber to whom a licence is granted under this code to deposit a performance bond in an amount to be agreed, but not exceeding (the sum to be stated) with the authority. This bond shall certify that all plumbing work performed by the licensee or under his supervision shall be in accordance with the provisions of the code, and that in the case of any violation of any of these provisions he shall pay all fines or penalties properly imposed by the council. A schedule of such fines or penalties accompanies this code of practice.
9. The authority shall specify the grades and quality of materials that are acceptable for use in the water and sewerage systems in its jurisdiction. The authority shall have the right to condemn any used plumbing materials or equipment which the authority deems to be so worn, damaged or defective that its reuse would constitute a sanitary or safety hazard. Such condemned material shall be promptly removed from the site and shall not be reused for plumbing in

the area under the jurisdiction of the authority. It is not the intention of this paragraph that used material which is capable of satisfactory reuse shall be condemned solely on the grounds that it is not new.

10. The duly delegated representative of the authority (referred to here as “the inspector”) shall have the right of entry into premises for which proposals for the installation of plumbing systems have been submitted to the authority, or in which plumbing has already been installed. Such entry shall be made at a reasonable hour and in the company of a representative of the owner or occupant.
11. Particular premises in which there exists any dual water system, premises in which food, drink or other material susceptible to contamination is prepared, stored or offered for sale, and any other premises which in the opinion of the authority present any special health hazards, shall be periodically examined by the inspector, after a minimum of 24 hours’ notice has been given to the owner or occupant, to confirm that the plumbing system is being maintained satisfactorily and in conformity with the code.
12. In the event of any breach of the code the authority shall, within one calendar month of the contravention’s being brought to its attention, serve notice upon the offender specifying the nature of the offence and the measures required to remedy it. At the same time, where applicable, it shall draw attention to the statutory penalty specified for the breach of the code, as listed in the schedule of penalties accompanying and forming part of this code of practice. Payment of the penalty and completion of the specified remedial works shall discharge the offence.
13. In the event that the person receiving notice from the authority disputes the offence in writing within 60 days of receipt of the aforesaid notice, the authority may take steps to refer the dispute to a court of law or to a form of arbitration to be agreed upon by the parties concerned, both sides to be bound by the decision so reached.
14. The authority may refuse to grant permission for a plumbing installation to be connected to the public water mains or sewers if it has reason to believe that the system contravenes the plumbing code. In such a case the owner or occupant of the premises concerned may call upon the authority to provide details of the alleged infringement of the code. In the event of dispute the matter shall be referred to a court of law or other form of arbitration.

The model code may need to be varied depending on factors such as the following:

- whether or not the “authority having jurisdiction” for plumbing is also the water and sewerage authority;
- if a single municipal, state, or provincial authority has coverage of a number of local communities;

- whether of not there is a national system for the training and examination of plumbers;
- whether the plumbing authority is also responsible for the administration of building regulations.

The following sections elaborate on the code of practice and provide additional context and discussions on particular aspects of the code.

7.2 Applications for approval to install plumbing systems

The process of application for a plumbing proposal will vary from authority to authority. Some authorities may only require a written application, and others may require plans and figures detailing the plumbing proposal supported by existing building details:

Application for the authority's approval for plumbing proposals in accordance with paragraph XXX [page YYY] of the plumbing code of practice shall be in such form and must be accompanied by such plans as the authority may require.

If the authority requires standard forms to be used for applications, approvals, appeals or other purposes, a schedule with a sample of forms can be attached to the code or made readily available by other means.

Where an authority requires plans to accompany applications such requirements should also be clearly defined. If these requirements may be relaxed in certain cases those circumstances should be described in the text.

A sample description of plan requirements is given below:

Plans accompanying applications for permission to install, extend or alter plumbing systems must be submitted in duplicate and one copy will be retained by the authority. The second copy will be returned to the applicant with the authority's formal approval.

Plans shall consist of elevations and sections as necessary, drawn to a scale of not less than 1:100, showing the following details in relation to all structural features of the building:

- (a) Every plumbing fixture, soil-pipe, drain, water service, ventilating pipe, storm water pipe, grease-trap, interceptor or other apparatus, if required, including the size and gradient of all drains and the diameter of all other piping;
- (b) The height and position of chimneys, windows or other features of the building within a distance of 6 m (20 ft) from the open end of any soil-pipe or ventilating pipe;
- (c) The level of the lowest floor of the building and of the surrounding open spaces, and the relative level of the highway, street, lane, and of the invert of any sewer which is to be connected to the drains.

A block plan, to a scale of not less than 1:1000, shall also be provided showing the premises at which the work is to be carried out, the limits of the property, the

positions of the public water main and any sewer at which connections will be made, together with other relevant details. The premises must be accurately identified by property number or name and street name. The position and diameter of the proposed water service between the main and the premises, as well as the size, gradient and line of any drain, septic tank or other method of waste disposal, must also be shown.

Most authorities will not permit the discharge of storm water into the authority sanitary sewerage system. Plans of storm water drainage may be required by some other authorities.

The plan must include, or be accompanied by, adequate specifications and descriptions of the work proposed. They must be signed by the applicant, who shall state whether he or she is the owner, occupant or agent of the property. If the applicant is not the owner then the owner's name and address shall be shown.

The plans must indicate the intended use of each building covered by the application. Except in the case of single domestic units, the estimated daily consumption of water on which the plumbing design has been based must be clearly shown. Additional allowances may also be required for firefighting services.

If it is intended that the water service pipe, drain or any other part of the plumbing system shall cross any land or property that is not under the same ownership as the premises to which the application refers, then the name and address of the owner of such other land or property must be shown and an indication of the nature of the agreement covering way-leave and right of access for maintenance and repair must be given.

The application accompanying the plans should also give the name and registration number of the licensed plumber who will be responsible for carrying out the work in accordance with the code.

In some cases an application for approval of plumbing proposals may be accepted by the water and sewerage authorities as an application of permission to connect to the main and sewer. In other instances a separate approach is required, and it is essential to make the appropriate procedure clear by reference in the code.

7.3 Setting plumbing standards

There are certain details included in the code that could be regarded as regulations emanating from authorities other than those responsible for plumbing standards. For example, it is usually considered most desirable that individual dwellings should each have a separate connection from the water main and to the public sewer. However, there are occasions, such as when crowded estates or properties remote from public services are dealt with, when this requirement is relaxed. This is usually done with a special agreement whereby those who share a combined service accept responsibility for a proportion of future maintenance costs.

Another detail that should be specifically defined is the boundary between public services and private plumbing. Where water mains and sewers are laid under the public road or street it is common practice for the respective authorities to accept responsibility for the drainpipes and service connections that lie between the boundary of the property to be served and the public main or sewer. Sometimes the authorities concerned install these pipes themselves and charge the applicant for the initial cost; sometimes the licensed plumber makes the connection and lays the pipe, which the authority takes over upon completion; sometimes the water authority provides an underground valve on a service line just within the property boundary, and the owner accepts responsibility beyond that point. In the same way the sewerage authority may construct, or require the construction of, an access chamber on the border between private and public land. These practices may vary in different jurisdictions, but in any case it is essential that the one that is to be adopted should be clearly defined, preferably in the code.

7.4 Quality assurance and testing

Upon approval of the application the authority will issue a permit to undertake the work within a stated time, and specify the tests to be applied to the plumbing system upon completion.

It is the responsibility of the applicant to ensure that the work is executed in accordance with the plans and specifications submitted with the application, and that any conditions attached to the permit are complied with. The authority's inspector will have the right of entry to verify that the terms of the permit are being observed.

Upon completion of the plumbing work, but before the ground has been filled in or the internal pipework hidden by structural features, the applicant should give notice that the system is ready for testing. The form of these tests should either be part of a national code or should be determined by the local authority. Their purpose is to ensure the watertightness of both water piping and the drainage system.

Unless otherwise required by a national code or authority, the water system may be adequately tested by filling the system from the mains and inspecting all joints and fittings for signs of leakage. Some authorities in high-pressure areas may require that the installation be tested by increasing the pressure above the water main pressure. The minimum test pressure of 1.5 times the operating pressure should be used unless the manufacturer's instructions indicate differently. In complex systems the authority may require an air test such as one in which the whole piping system is subjected to a pressure equivalent to 35 kilopascals (kPa) held for a period of at least 15 minutes. Where such tests are to be performed it is usual for the authority to lend or rent the necessary compressor and gauges, and

for the responsible plumber to connect these and set up the test under the direction of the inspector.

Tests on the drainage of the plumbing system are usually applied in sections. Underground drains are commonly given a water test or air test as soon as they are completed. After approval the ground can then be filled in, thus reducing the time that the site is disrupted. The usual procedure is to insert a drain plug in the sewer connection point or the access chamber nearest to the sewer (this may be at the boundary of the property) and to fill the whole of the subsurface drainage system with water. A head of 3 metres maximum to any section of drain may be applied by temporarily adding a short length of vertical pipe at the upper end. It is not always practicable to apply this head, especially if there are a number of gullies in the system, in which case the drains will be filled to the highest point possible and the test applied in sections.

The water should remain in the system for a minimum of 10 minutes for clay drains and 5 minutes for other materials, during which time the water level should not drop significantly. If the joints of the drain are of cement and are dry, the system should be filled at least an hour before the test so that no water is absorbed by the jointing material. If water is scarce, or if for any other reason the authority prefers an air test, the drains should be plugged and subjected to air pressure of 30 kPa for a minimum of 3 minutes without a drop in pressure. Excessive pressures of either water or air are undesirable on underground drain-pipes, which are not designed to resist such internal stresses. The joints (especially cement joints of clay pipes) may also become loosened or damaged if too great a head is applied from within. In such cases the test pressures can be reduced to provide a minimum of 10 kPa or 1 metre head.

As an additional precaution the lower access chamber should be inspected after the water test has been completed and the drains emptied, or after a period of rain, to confirm that there is no infiltration from the surrounding ground into the pipe.

Water tests may be applied to the drain outlets from fixtures within the building by filling the pipes up to the spill level of the fixtures. In multi-storey buildings, a water or air test may need to be done in sections of two storeys. An alternative is a smoke test, in which a machine is used to fill the internal drainage system with smoke under pressure from a testing machine. The vent stack must be plugged at its upper end as soon as the smoke emerges, and the pressure applied should not exceed 250 pascals or the liquid in the fixture traps will be blown out. The pressure should remain steady for at least 15 minutes, during which time all fixtures, traps and pipe joints should be inspected for signs of emerging smoke.

When the whole system has been successfully tested and inspected the authority may issue a certificate to that effect as evidence that the plumber's work has been properly carried out. In some countries it is required that the

plumber issue a compliance certificate indicating that the plumbing and drainage work complies with the regulations and, in effect, the plumber must guarantee the workmanship for a nominated period of time.

7.5 Disinfection of new plumbing installations

Any water used for testing the water piping should be from a safe drinking-water source, and after completion of the test it is good practice for the authority to require that the system be disinfected. One approach is detailed here. Disinfection is normally accomplished by dosing the storage tank with a chlorine compound (e.g. sodium hypochlorite or calcium hypochlorite) to produce a 20–50 milligrams per litre solution of free residual chlorine, running all taps and fixtures until the smell of chlorine is evident at all outlets, then closing all taps and fixtures and allowing the system to stand for an appropriate period (from at least one hour at 50 milligrams per litre to at least two hours at 20 milligrams per litre). It is then flushed to waste until the chlorine levels of the emerging water decrease to normal values. Other approved disinfectants may be used, for example appropriate concentrations of chlorine dioxide, but it is more difficult to obtain and handle than chlorine (bleach or bleaching powder). Of course, it is essential that the gaskets and fittings and other materials in the plumbing system have been selected to be resistant to damage from the chlorine or other disinfectant at the doses that would be used.

When disinfecting the system after installation, or when putting a system back into service after a serious contamination incident, it is necessary to calculate the approximate quantity of disinfectant to be used. This depends upon three factors – the volume of water contained in the system while no draw-off is taking place, the percentage of free chlorine (or other disinfectant) in the compound chosen and the chlorine demand of the water.

The cubic capacity of the pipework can readily be obtained by measuring the lengths of pipe of different diameters and multiplying by their cross-sectional areas. To calculate the figure accurately is a laborious process, and it is more practical to make a generous estimate since the disinfectant solution can be somewhat overstrong, but should not be weaker than specified. To the pipework capacity must be added the volume of the supply cistern and any flush tanks connected to the system. However, it is important to strive to achieve a relatively accurate calculation so excessive deterioration of fittings or other problems are avoided. Manufacturers' instructions should always be followed.

To obtain a 50 parts per million solution, 50 grams of free chlorine per 1000 litres (7 ounces per 1000 US gallons; 8 ounces per 1000 UK gallons)¹ will be

¹ Conversions: 1 ounce = 28.35 grams, 1 pound (lb) = 0.45 kilograms, 1 US gallon = 3.79 litres, 1 UK gallon = 4.55 litres.

needed.¹ The strength of the compound to be used (whether solid or liquid) should be known and the quantities adjusted according to the percentage of free chlorine. If, for example, a bleaching powder of 25% available chlorine is the agent chosen, 200 grams of the compound will be required per 1000 litres of solution (1.7 lb per 1000 US gallons; 2 lb per 1000 UK gallons). If the compound is in solid form it will be expedient to dissolve it immediately before use (Taylor & Wood 1982; IPHE 2004). Use the supernatant liquid.

Before dosing begins, all pipework should be flushed out, the incoming mains supply shut off and the system emptied by opening valves on all fixtures. The dead space in the supply tank below the lowest draw-off point should be emptied and cleaned out. Prior to emptying the plumbing system, all of the occupants of the building should be notified of the expected length of interruption of supply so that water for use during that period may be drawn off and stored. They must also be warned against using any flush tank or other fixture while disinfection is taking place.

With all fixture taps closed, water from the main is readmitted to the storage tank and the prepared disinfectant gradually added to the incoming supply close to the ball valve to ensure thorough mixing. Most, but not all, of the disinfectant should be added in this way until the tank is full. Water should then be drawn off from each fixture in turn until chlorine (as evidenced by the smell) emerges, after which the fixture taps are shut and left undisturbed for the required time. Flush tanks should be operated until the water they contain is chlorinated. The supply tank should then be topped up (using the remainder of the concentrated disinfectant) and the incoming supply shut off once more.

At the end of the contact period the system is once more emptied through the fixtures, mains water is readmitted to the supply tank, and fixtures such as sink or washbasin taps are opened and allowed to run until chlorine cannot be smelled. Analytical test systems are readily available to test for residual chlorine. This is unnecessary for water closets or other fixtures where the water will not be drunk or come into contact with the skin.

In buildings where no supply tank is installed and fixtures are supplied directly from mains pressure the procedure is more complex, calling for the use of a force pump, and this might be carried out by the public authorities, or according to their special requirements.

More elaborate disinfecting procedures may be required for complex systems, and for periodic maintenance of piping and storage tanks in buildings serving special purposes, for example hospitals, boarding schools, residential hotels and

¹ As plumbing in many countries still uses non-metric measures for fixtures and fittings and their use, non-metric equivalents to standard SI units are given, where appropriate, in this book. These equivalents may be rounded off, according to requirements in each instance.

food establishments. The authority may require a bacteriological test (*E. coli* or faecal coliforms) of the water in the system after disinfection of the plumbing system has been carried out. After any disinfection procedure is carried out, the contractor should issue a certificate of conformity.

8. Implementation of the plumbing code of practice

If a plumbing code of practice is to operate effectively, it is important that the authority responsible for its implementation fully understands its roles and responsibilities and the limits of its powers. These roles will vary according to the scope and power of the authority, but usually include the interpretation of the code, approval of applications, inspection and certification of new work and functions such as periodic inspection to ensure continued compliance and penalties for non-compliance.

8.1 Application and approval process

The plumbing code of practice will set out requirements regarding the submission of application forms and plans and other essential information relating to the proposed plumbing work. “Plumbing work” must be clearly defined within the code of practice and it is likely to cover new installations, as well as substantial replacements or additions to existing systems.

Types of work that are exempted from the need for approval, such as the repair or replacement of a single plumbing fixture or small domestic installations connected neither to a water main nor to a public sewer, should be defined. Inspectors employed by the authority should be competent to give guidance in cases of doubt. Borderline cases are most likely to arise in industrial and commercial premises, where temporary piping is subject to continual adjustment and realignment. These realignments must be carefully scrutinized where cross-connection with unsafe sources might occur. Some countries make an exception regarding domestic property where the work is to be carried out by the owner, but others regard this exemption as dangerous as it may result in defective installations that may contaminate public supplies.

Normally the responsibility for making application to the authority lies with the owner of the property or the plumbing contractor. Most authorities require applications to be made on standard forms; this saves time by ensuring that essential items of information are presented in a recognizable and uniform manner. The detail required on the application form will depend on the extent and complexity of the work in question. All application forms should include the name of the plumber or plumbing business responsible for the work and the registration number of the individual or business.

Applications for particular types of work usually need to be supported by

plans, and the code should contain details of the authority's requirements. Some flexibility is appropriate. Relatively simple domestic jobs may require basic plans whereas proposals for larger installations in multi-storey apartments or in industrial or commercial premises should be shown in considerable detail. In some cases it may be appropriate to require no more than notification of certain categories of work rather than require the submission of a formal application for approval. This will largely depend on the nature of the work, the inspection resources of the authority (which are often limited) and the terms of the code of practice. Advance notification is typically required and the code of practice should specify the number of days before the work is due to begin. The authority will usually reserve the right to inspect the site at any time before, during or upon completion of the work, and prior to it being put into service. Failure to notify is likely to be treated as a breach of the code.

Once the application and plans are submitted an inspector should be given responsibility either to approve or reject plans or to recommend their approval or rejection to the authority. Rejection should only be on the grounds that the proposals do not comply with the code of practice, or may indicate a health risk or significant failing, and the reasons for rejection should be specified by the inspector. Negotiations would usually be capable of resolving differences. There have been examples of bribery of inspectors and this should be scrupulously prevented. Inspectors must be well trained and aware of their fiduciary responsibilities as public health and welfare officials.

8.2 Certification of conformance

After the plans and applications are approved the plumber should notify the inspector (often on a standard form) when work is due to begin. Similar notification will be required of the date when the completed work is ready for testing and approval. Between these dates the inspector should have the right to enter the premises at any reasonable hour to inspect the progress of the work and to examine any materials used. At the conclusion of any test (whether intermediate on part of the system or final on the completed installation), the inspector should confirm the findings in writing, usually on a standard form.

In some countries a system of self-certification operates. This allows appropriately qualified and approved plumbers or plumbing businesses to issue a certificate confirming that they have carried out the work in accordance with the plumbing code of practice. Such self-certification will be limited to those who have met specified approval criteria (such as holding formal plumbing qualifications, being trained in the content of the code itself and holding appropriate liability insurance coverage) and may be limited to particular types of work. It might also be possible under such a system to waive the normal requirements for notification or approval of certain types of work where the work is to be undertaken by a plumber or plumbing business with a proven track record that meets

the authority's approval criteria. Work completed under a system of self-certification may also be subject to periodic audit by the authority, and the ability to issue future self-certification may be withdrawn in the light of any significant problems arising from the audit.

The authority may provide its own apparatus for testing (such as pressure-measuring equipment and drain plugs) or it may require the plumber to supply these items. Where the authority's equipment is used, it is common for the plumber to collect it, set up the test and return the apparatus after successful completion. A rental fee may sometimes be charged by the authority for this service.

8.3 Periodic inspection

An essential feature of risk prevention and risk minimization strategies is that facilities are regularly monitored and maintained. As part of its responsibility for protection of public health and safety, the authority must make certain that plumbing systems are assiduously maintained at the standard required in the plumbing code of practice. Ensuring ongoing compliance with the code of practice through a process of periodic inspection of installations is expensive, so appropriate priorities need to be set.

For systems that have the potential to pose a serious risk to public health (such as premises where food or drink is processed, hotels and lodging houses, and industrial or commercial premises) it may be a condition of the authority's approval that the plumbing system should be retested at specific intervals (such as every two years), and that such tests should be witnessed by the inspector. The inspector should be satisfied that no cross-connections or other violations of the code have occurred since the previous inspection and test.

8.4 Penalties and enforcement

The long-term effectiveness of a code of practice depends on effective enforcement. Any contravention of the provisions of the plumbing code of practice should constitute a breach of the law, and should be punished accordingly after the nature of the offence and the identity of the offender have been established. Because this process can be costly and time consuming, comparatively minor breaches are rarely followed up in this way. It is common practice to annex to the code of practice a schedule of administrative penalties related to violation of particular sections. In case of dispute over breaches the authority may take the matter to the courts, or settle it by arbitration if the offence is of a technical nature. More drastic sanctions such as the withdrawal of the licence of a practising plumber, refusal to permit connection of a new system to the public mains, or disconnection of an existing installation are reserved for serious breaches of the code of practice. Some examples might include carrying out work while not being registered or licensed; altering plumbing systems without notifying the

authority; allowing water to be wasted or contaminated through misuse or neglect of pipes or fittings; using water for unauthorized purposes; interfering with valves or other apparatus belonging to the authority, or tampering with the operation of any meter upon which water charges are based; and refusing admission to the authority's inspector, or otherwise obstructing the inspectors in the performance of their duty.

8.5 Financial aspects of administration of the plumbing code of practice

Implementation of the code of practice and ensuring ongoing compliance have necessary costs. These include costs of hiring staff to process applications, inspect work and test systems, as well as office accommodation, training and management, printing, transport and other incidental items. In some countries these expenses are recovered from applicants through fees for particular services (such as an application fee or an inspection fee) and these fees are shown as a schedule in the code of practice. They should be clearly distinguished from the fees or charges that may be levied by the water, sewerage or other authority for specific items of work such as for making a connection to a water main or sewer, for replacing the highway surface after backfilling a trench, for clearing a septic tank or for permitting discharge of industrial waste into public sewers.

Many countries prefer not to include the collection of fees as part of the code. One justification for this approach is that the services described are provided to the community as a whole and should therefore be borne by the community as a whole through the taxing system. Another reason is that it is difficult to produce a scale of fees where the amount charged is fairly apportioned in accordance with the service provided. However, it is possible that the reason sometimes is more practical, in that the income likely to be received may be more than outweighed by the cost of extra staff and other expenses incurred in collecting and accounting for it.

9. Training and registration of plumbers

Plumbing is a craft calling for technical knowledge as well as manual skills. A national plumbers' guild or similar appropriate institution can approve standard methods for different plumbing practices as a basis for training and for examination and certification of plumbers.

Training programmes must ensure that both theoretical and practical aspects are fully covered. Most plumbing training systems specify two levels of achievement. The first of these describes a person who has gained the knowledge and demonstrated the skills necessary to work independently without supervision, usually designated a journeyman or journeywoman. The second is a master plumber, a designation applied to those who have completed a number of years as a journeyman, and who have demonstrated a superior level of skill and understanding in the profession. A master plumber is deemed competent to supervise apprentices and to oversee major construction projects that include the installation of highly complex systems. Master plumbers also may work as inspectors for local government authorities. Many countries have formal accredited training programmes for those wishing to gain the title of master plumber. In many developing countries, where the formal education system offers limited opportunities for the designation of master plumbers, it is fundamental that the water authorities themselves make an effort to support the establishment of schools for plumbers conducive to the formation of this type of professional.

9.1 Training prior to admission to the plumbing trade

In most developed countries, training for admission to the trade is either through formal apprenticeship lasting four to seven years, or through training at a post-secondary institution, such as a community college or technical college. When training in plumbing is provided by a college or other tertiary institution, a diploma or certificate may be awarded when a student completes the required course of study. However, while knowledge acquired from textbooks and lectures is important, it alone does not fully prepare an individual for the demands of the plumbing workplace. Those knowledge-based programmes must be coupled with effective on-the-job training in the field, under the supervision of a fully qualified and experienced plumber (usually a master plumber).

9.2 Licensing and registration

Training programmes, whether apprenticeship or college based, are generally designed to prepare journeymen or journeywomen to successfully meet local licensing, registration or certification requirements. The granting of a licence is recognition of the ability of the person to carry out satisfactory plumbing work without supervision. Where it is a legal requirement to be licensed, registered or certified, the licensing authority has the power to suspend or revoke a plumber's licence for cause. This provides an important incentive for a licensed plumber to maintain good standards of performance and to avoid breaches of the local code of practice. Plumbers may also be asked to provide evidence of good character and reliability before they are licensed. Plumbers may also be required by the licensing authority to provide a deposit or some form of indemnity or performance bond to cover the cost of repairing defective work before a licence is granted.

In some countries a unit of the national government, such as the public works department or the national water board, takes responsibility for all aspects of training and registration. In these cases, the relevant ministry conducts training courses, holds examinations and maintains a register of qualified plumbers ranked according to both practical and theoretical experience. Plumbers who are listed on the register are not required to take further technical examinations to obtain a licence to practise their trade. When training is based upon an apprenticeship system, the apprenticeship programme should be accredited and monitored by an appropriate third party or by a state or national apprenticeship agency. The third party may be a national sanitation or health organization, a building research institute, a trade union or a professional society.

Some countries do not regulate the activities of plumbers by law. This lack of regulation and oversight may contribute substantively to poor plumbing, especially in developing countries.

9.3 Establishing a training programme

The first challenge in setting up a new formal training programme in a city or country where no such programme has existed is the recruitment of qualified and experienced individuals to help design and establish the training and certification programmes. This may involve the importation of well-trained plumbers from outside the local area or from nearby nations. The first training programmes can be set up on a small scale, and these pilot programmes can later be expanded to meet the needs of the region. Numerous models for these training programmes exist and they can be the basis for the programme targeted to a specific jurisdiction.

10. Standards for materials used in plumbing systems

10.1 Standards

Standards are sets of rules that outline specification of dimensions, design of operation, materials and performance, or describe quality of materials, products or systems. These standards should cover the performance expectations of the product for particular applications, as well as, in the case of drinking-water contact, the chemicals that may be leached from the product into the water. The intent of standards is to provide at least minimum quality, safety or performance specifications so as to ensure relatively uniform products and performance, and to remove ambiguity as to the suitability of certain commercial products for particular applications. They reduce the risk of error by installers, and also provide assurance to the plumbing system owners. Standards also provide direction to manufacturers in respect to the expectations of the products that they produce. Internationally accepted standards provide economies to both the manufacturer and the user by reducing the number of products of the same type that must be produced. Standards may be developed by industry, non-profit organizations or trade associations, as well as national or international bodies. The existence of credible standards and certifiers relieves the regulatory authority of the need to develop its own case-by-case standards and product assessment system.

The existence of a standard does not always ensure that all available products meet a specific standard. In order to be confident of uniformity in a product there must be checks and balances. This is accomplished by assessment conformity. Assessment conformity, product listing and certification all have the same meaning. Simply stated, it means that a product, material or device has been tested and verified to meet the specification that has been developed. There are at least three types of certification: where the manufacturer or seller self-certifies and guarantees the product by warranty or contract; where the manufacturer or seller obtains verification by a contract laboratory; or where the specific commercial product (not just the class of product) has been evaluated by a credible independent third-party testing or certifying organization that is in no way related to or a part of the manufacturer or seller, and which has a system for policing the validity of its certifications.

Assessment conformity, by any name, means that a product, service, material, system, device or component has undergone testing to ensure it meets the

intended standard for such product, material, system, device or component. There are several organizations that perform assessment conformity and, in most cases, if a specific product, material, system, device or component meets a designated standard, the testing organization may allow placement of a mark or logo of the organization on the product, material, system, device or component to certify that the relevant standard was successfully met.

10.2 Products and materials used in plumbing

10.2.1 Standards for plumbing products and materials

The durability of a plumbing system is dependent on the quality of its component parts and the assembly skills of those who install it. No plumbing system, however well designed, can be expected to operate safely or hygienically if the products or materials used are unsatisfactory. The inverse is also true – if the best-quality products or materials are used but are installed incorrectly, the system will be a failure.

Most industrialized countries have national standards or codes that set out the minimum requirements for the material specifications, design and use of specific plumbing products. However, plumbing codes of practice vary considerably according to the extent to which they specify the detailed standards for plumbing products and other matters. Some countries take the view that the level of detail should be minimized, whereas others are very prescriptive. However, even prescriptive codes should allow for the introduction and innovative use of promising new products, materials and installation practices without undue delay. Countries that are members of the International Organization for Standardization (ISO) may choose to adopt the ISO framework as a minimum standard set for plumbing products and materials. WHO Guidelines for Drinking-water Quality should be used as reference in decisions concerning health-related matters. Several national and international standards and certifying organizations utilize and expand upon those basic principles by identifying specific products that comply. It is important to ensure that commonly used plumbing products and materials are of the same type, at least throughout a country, to take advantage of economies of scale in manufacturing and to ensure easy accessibility.

The process of certification of quality of plumbing products may necessitate the setting up of testing establishments where products can be assessed. In many cases it will be more economical to simply adopt an existing qualified standards and certification programme that already has international acceptance. This will also avoid unnecessary proliferation of standards. Product certifiers and their testing facilities must be of the highest standard and subject to external auditing.

The application of suitable materials and products must be supported by adequate levels of training of plumbers who use them so that they can identify and use only appropriate products.

10.2.2 Selecting suitable products

Numerous standards and certification bodies exist nationally and internationally, so it may not be necessary for a country to develop a unique set of standards. It could decide to adopt one of the existing systems and require that products are certified to meet that system's requirements. In judging a product or material, the regulating authority (or certifier) must consider factors such as the following:

- Is the product or material under consideration suitable for the application or purpose?
- Will it be harmful to the health of the community in its normal use?
- Is there a risk of these materials being released into the environment (e.g. the water) in the first instance or after the working life of the product or material has expired?

All pipes, valves, taps and other fittings used for the supply of drinking-water or the removal of wastewater must not contain harmful substances above the specified amount that could leach into the water. Lead, cadmium and arsenic are examples of many possible contaminants that could be present. The pipes, valves, taps and other fittings must be capable of conveying water at a nominated pressure within a prescribed environment, and must be of sufficient strength to contain anticipated internal pressures. They must also be able to withstand external pressures if they are to be buried. The impact of environmental factors such as heat, cold, expansion, contraction, corrosion, pH and bacteria levels also need to be considered.

WHO and many national authorities have developed guidelines or standards that set out the maximum acceptable levels of metals and chemicals and other contaminants in public drinking-water supplies (WHO 2004a). These are then converted to apply to contaminants that may leach from the fixtures and the associated network of piping systems. For example, a pipe standard might require that the leaching level of a heavy metal must not exceed 10% of the drinking-water standard based upon a standard test that simulates use and exposure conditions. Some authorities also insist that piping systems for soil and waste-water drainage systems comply with the same material criteria. Manufacturers in these areas are obliged to comply or risk losing market share or perhaps face prosecution. The standards set for materials in contact with drinking-water are minimum requirements and are based upon a specified use condition range; for example, a product suitable for a cold water system will, in most cases, not be acceptable for a hot water system. It is common for piping and construction materials, as well as the water being conveyed, to be seriously affected by aggressive environments and local conditions. In summary, it is still very much in the hands of the individual project adviser or installer to ensure that the plumbing products and materials selected for the application are in accordance with official

requirements, will not be unduly affected or influenced by local factors and are correct for the application.

As well as deciding what is an acceptable plumbing product or material, the water authority or governing organization must set standards for the level of training attained by the installation personnel, a point that cannot be over-emphasized. In some countries, for reasons of economy, transport, proximity to manufacturing plants or restricted access to international markets, the choice of available materials for plumbing products and piping systems is often limited. Socioeconomic reasons may also dictate the quality and standard of plumbing in domestic dwellings.

10.3 Metallic and non-metallic materials used in pipework

There are two families of materials available for water pipework systems: metallic and non-metallic materials. Of these the most commonly used materials for drinking-water supply piping are galvanized steel or iron, copper, polybutylene, unplasticized polyvinylchloride (PVC), chlorinated polyvinylchloride (CPVC) and polyethylene (PE). Metal alloys, which far exceed the performance specifications of their respective parent materials, are also widely used. New materials and construction technologies are continually being developed for the building industry and the plumbing industry. Without some form of control at the respective levels within the plumbing and building industries it would be easy for unscrupulous manufacturers to use inferior materials to the detriment of installers and end-users. This can ultimately damage the environment and the health of the community and lead to greater costs later when systems fail prematurely.

10.3.1 Galvanized steel or iron

Galvanized steel or iron was the traditional piping material in the plumbing industry for the conveyance of water and wastewater. The term “galvanizing” once referred to hot dipped galvanizing, in other words total immersion in molten zinc after pretreatment cleaning. This technology afforded a reasonable level of internal and external protection to the metal pipe. In more recent times, the use of electroplating technologies has provided a more attractive external finish, but little or no internal protection. Although still included in many codes of practice throughout the world, the popularity of galvanized piping is declining. It is still being used extensively in the fire protection industry, but overall there are increasing limitations on how and where galvanized piping may be used. Internal and external corrosion is a particular problem where galvanized steel or iron piping is connected to dissimilar materials, such as copper alloy (brass) in taps and valves. Internal corrosion can add iron, which causes an undesirable taste and may also cause unsightly precipitation of iron salts on clothes. Aesthetic guidelines contained in the WHO Guidelines for Drinking-water Quality address these matters.

The use of galvanized steel or iron as a conduit for drinking-water is a greater problem where the water flow is slow or static for periods of time due to rust discoloration caused by internal corrosion. Galvanized steel or iron piping may also impart an unpalatable taste and smell to the water conveyed under corrosive conditions. Galvanized steel piping systems are generally accepted for outdoor use, but because of the size or bulk of the pipe and fittings, and the inflexibility of such systems overall, the material is not desirable for internal water plumbing. Galvanized pipe is heavy to handle and is generally joined by threading and screwing the components together. This is a lengthy procedure when compared to the assembly of competing non-metallic pipework systems.

10.3.2 Copper tubing

Copper tubing is extremely flexible in the hands of a competent installer and smaller in overall diameter than the equivalent galvanized steel pipes and fittings. Corrosion can be a problem, though usually to a lesser degree than with galvanized steel; care must be exercised to avoid contact with dissimilar metals. Copper tubing, due to its thinner wall section, is relatively light to handle and is available in coil form or straight lengths as required. When assembled and installed correctly it can blend into building structures without difficulty. Piping systems can be assembled with the aid of compression fittings, couplings, or by lead-free solder or brazing. A high degree of skill is required of installers who perform braze welding. Compression fittings are much simpler, but may be obtrusive.

Copper tube or pipe is also particularly useful for hot water supply systems. However, heat loss can become an issue if adequate insulation is not provided. As with all metallic materials, the risk of electrolytic corrosion should be considered. This occurs most commonly where galvanized steel pipes or fittings connect with copper alloy (brass) fittings.

System designers must be aware that water flows through copper tube piping systems must not exceed 3 metres per second. When this occurs there is a high risk that the internal bore of the piping system will be eroded by high flow and velocity scouring. Due to its electrical conductivity there is a need for care to ensure that grounding connections are separated from piping systems and any electrical wiring.

10.3.3 Polybutylene

Polybutylene in non-metallic piping systems is becoming accepted as a suitable material for the conveyance of drinking-water in domestic dwellings in some industrialized countries. However, it is banned by plumbing codes in USA due to problems with leaks at joints resulting in significant water damage in dwellings. It is a light, flexible material that is easy to handle and install. It can be used

in domestic dwellings for both hot and cold water supplies. Caution must be exercised as it can suffer degradation if exposed to excessive pressure and temperature, and exposure to ultraviolet light (sunlight) is also detrimental to the material.

There are several jointing systems available for the connection of polybutylene pipework systems, including electrofusion and socket fusion welding and a variety of mechanical jointing methods. Some mechanical joints rely on an integral grab ring while others have a compression-type joint, via a nut or a compression crimp ring or band. Some jointing systems comprise metal in-line as well as end-of-line fittings, which may not be appropriate in some locations or conditions. Polybutylene pipe is generally available in straight lengths up to 6 metres or coils 60 metres in length.

10.3.4 Chlorinated polyvinylchloride (CPVC)

CPVC is widely used in water and sanitary systems for hot and cold water distribution. It is a thermoplastic produced by polymerization of vinyl chloride, with additional chlorination. CPVC piping is manufactured by extrusion methods in sizes of diameter 0.25 inch (0.635 centimetres) to 12 inch (30.5 centimetres) in Schedule 40, Schedule 80 and standard dimension ratio (SDR) dimensions.¹ It is manufactured to copper tube size (CTS).² It offers much better resistance to corrosion and has a high tolerance to acids. It is fire resistant, though toxic fumes are emitted when it is burned. CPVC is lightweight, non-toxic and odourless, and reduces growth of fungi, algae and bacteria. It is designed to withstand continuous operating pressure of 600 kPa at a temperature of 95 °C. Pipe and fittings are readily cut, and joined by solvent welding.

10.3.5 Unplasticized polyvinylchloride (PVC)

PVC, when used with a solvent cement jointing system, is comparable in bulk to galvanized steel or iron for drinking-water piping, but much lighter. It does not suffer the same corrosion problems internally or externally as does galvanized steel. However, it is susceptible to physical damage if exposed above ground and it becomes brittle when exposed to ultraviolet light. The pipe is light to handle, but it is too bulky for aesthetically acceptable internal use in domestic buildings. It is used extensively around the world for drainage (waste or soil and storm water) applications.

¹ Pipe dimensions are nominal rather than actual; 1-inch Schedule 40 pipe, for example, has an actual outside diameter of 1.32 inches and an inside diameter of 1.049 inches.

² Copper tube size (CTS) was added to iron pipe size (IPS) when copper tubing was developed. CTS is closer to actual size than IPS. Generally, a product made in IPS is called “pipe”, and a product in CTS is called “tubing”. CPVC is an exception, being called “pipe” but being sold in CTS.

PVC is available with a solvent cement or rubber (elastomeric) ring jointing system for internal or external drainage systems. Caution must be exercised when using PVC close to water heaters and similar heat sources. In addition to the inherent problems associated with the expansion and contraction of PVC, the material will soften and deform if exposed to a heat in excess of 65 °C.

10.3.6 Polyethylene (PE)

PE pipes and fittings of numerous types and designs have been available for over forty years. The market requirements today have been refined to three general groupings, as follows:

High-density PE is available in a post-manufactured stress-relieved state (best-practice PE), or as extruded product with no treatment. It is used mainly for drainage applications where it can withstand higher temperature discharges than PVC. To avoid ovality and installation problems when laying to grade the pipe is best used in straight lengths, normally up to 6 metres long. Jointing is achieved by electrofusion or butt-fusion welding or with compression-type joints for smaller diameter pipes and fittings.

Medium-density PE is more flexible than the high-density pipe. It has a slightly thinner wall thickness and is capable of withstanding higher internal pressure. It is the preferred material for long-distance drinking-water piping. Because of the application and the robust nature of the material it is generally available in coils of up to 200 metres (650 feet) length, depending upon the diameter. The method of jointing is the same as for high-density PE pipe. In colder climates coiled polyethylene piping can be very difficult to use and may be impractical.

Low-density PE is suitable for the irrigation industry, where operating pressures are very low and a high degree of flexibility and low cost is required. Low-density PE pipe and fittings are not acceptable for use for connection to the water mains in many countries because of the low pressure rating of the material and its high leakage rate.

10.4 General issues related to use of plastic piping

There are numerous composite PE piping systems available and new plastic materials are constantly being developed. Each must be considered on its merits for the particular application in hand. In some types, the molecular structure is cross-linked to attain a stronger product with a reduced wall thickness, allowing savings in the amount of raw material needed. Combining different types of raw material together with lamination, overlay extrusion or simply adding selected reinforcement into the extrusion process can further enhance specific qualities of the structure of the material to make it more acceptable for use in both domestic and specialized plumbing applications.

Providing that the health, safety and durability standards are met, pipes and fittings manufactured from plastic materials have many advantages for use in both hot and cold water plumbing systems. They are light, easily handled and transported, and require fewer joints than metal pipes when available in long lengths. Pipes and fittings manufactured from plastic materials may cost more to purchase than metal pipes or tubes and their ancillary fittings, but the time spent installing a plastic pipe system is generally much less than a metallic system and this may result in overall savings.

Where a large project is to be undertaken, it is not uncommon for a plastic pipe manufacturer to bring in moulding or just extruding machines with the appropriate dies, tooling and raw materials, and commence manufacturing in close proximity to the market or project site. This in turn can bring about savings in transportation and handling costs. Long delays in supply can also be averted, resulting in rapid on-site progress. Sometimes only the pipe is made at the remote locations due to its bulk, and fittings, especially when there is a large and varied range, are brought in separately.

It is important for plumbing systems that different pipe types remain separated and not intermixed with similar products. For example, rainwater or storm water drainage pipes and fittings should not be used for sanitary plumbing (soil, waste or vent pipe) applications. They have a thinner wall section and are not designed for higher temperatures or deeper than near-surface and above-ground applications where durability is not a major concern. Conversely soil, waste and vent pipes and fittings could be used for rainwater or storm water, but they are unnecessarily expensive for those applications.

Some standards and codes call for different-coloured pipes and fittings to define the designated application of the product and to assist installers, as well as for future identification to prevent cross-connections. For example, PVC pipe and fittings are easily manufactured in various colours; other materials that are not so easy to colour may rely on a stripe of colour set onto the pipe during extrusion or painted bands and labels applied after installation, with specific markings or instructions with regard to fittings, etc. Other authorities, such as electricity and gas providers, may also utilize colour coding for their buried pipelines. To avoid confusion care should be taken to coordinate the identification strategies or policies for all pipes and services.

10.5 Earthenware pipes

Earthenware is also referred to as glazed stoneware, terracotta or vitrified clay. Furnace-baked earthenware has been the most commonly used material for underground drainage systems. It can be locally produced in almost any country provided there is a source of good-quality clay and an energy supply to fire it. In the past, glazing was achieved by throwing salt into the fire towards the end of the firing process. This method of salt glazing damages kilns and does not

always create an even finish or glaze. Advanced material and management technologies, combined with the use of sophisticated tunnel kilns, have in recent years seen the emergence of a completely new generation of vitrified earthenware pipes and fittings of a quality previously unattainable. They are chemical and temperature resistant with elastomeric jointing couplings. The high cost currently precludes their use in domestic dwellings, but there are many special commercial or industrial applications.

Installing old-style earthenware drainage systems is difficult and maintenance is demanding because of breaks and blockages. The inherent rigidity of the system can cause the pipes to break loose at the joints or cause the pipe itself to break close to the joint just behind the collar. Tree roots can grow into the open joint or broken pipe and will eventually block the drain. In some cases groundwater can infiltrate the drain, causing the system to become overloaded. There is also the risk of contaminating the groundwater by the leakage of raw sewage from the broken joint or pipe. A further disadvantage is that earthenware pipes are heavy to transport and expensive to install compared to lighter materials such as plastics.

Plastic, mainly PVC, is now the most commonly used material for drainage systems for the conveyance of sewage and wastewater from dwellings. Other materials, such as cast iron, ductile iron, copper, fibre cement and vibrated concrete, are sometimes used for drainage systems. Each has its strengths and weaknesses; their longevity in service is dependent on how well they are installed, the nature of the water or other materials passing through them, and the installation environment.

10.6 Design of plumbing fixtures

Both the component materials and the design of plumbing fixtures (baths, wash-basins, sinks, tubs, toilet pans, etc.) should be subject to standards and certification to ensure integrity and safety. Fixtures should be free of sharp projections and sharp corners that may cause injury. In order to prevent drainage sewer gases from entering the area where the fixture is installed, a fixture trap should be incorporated into the fitting, or provision should be made for fitting one at a later date. To protect the drinking-water supply, all plumbing fixtures should be designed so as to ensure that incoming water is delivered through an air gap. Tapware should be appropriately matched to the fixture that it is intended to serve. When installed, all taps and water delivery outlet fittings should have an adequate clearance between the water outlet and the spill level or water overflow level of the fixture being served. It is possible for the overflow on any fixture to become blocked, which would compromise the air gap by not leaving the correct clearance. In situations where a portable or flexible hose or tube is attached to the water outlet, and an air gap cannot be provided, an appropriate backflow prevention device should be installed in the pipework supplying the fixture.

Local usage and customs should be considered when assessing plumbing requirements. An example is the choice of pedestal toilet bowls or squats. It may also be necessary to conduct training sessions in the use of particular fixtures to ensure that they are maintained in a satisfactory and hygienic state. In some areas it is customary to provide a drinking-water supply tap adjacent to the toilet fixture to facilitate personal ablutions. In such cases strict precautions must be taken to prevent contamination or cross-connection with the drinking-water supply system.

10.7 Sanitary fixtures

Sanitary fixtures should be durable, smooth and impermeable to water. There should be no hidden surface that can become fouled or polluted. Both internal and exposed outside surfaces should be accessible for cleaning. The most common and most economical material for domestic fixtures such as toilet bowls, urinals, and washbasins is vitreous china. For more durable day-to-day use in kitchen sinks and laundry tubs, stainless steel is recommended, but enamelled pressed steel and suitable plastic materials may be acceptable.

Plastics are commonly used for bathtubs, shower trays, laundry tubs, cisterns, washbasins and toilets and are often reinforced with fibreglass for extra strength and durability. Plastic materials, although generally durable in themselves, are readily prone to surface damage such as scratches and cuts. Stainless steel is a preferred material for plumbing fixtures where there is a risk of damage from users, such as in institutions and public amenities. Stainless steel is currently the only suitable choice in commercial or industrial food preparation areas.

10.8 Concrete products

The manufacture of plumbing products of any kind is expensive because of the capital investment in plant and the associated tooling. Unless high production volumes are anticipated, it is often more economical to import such items. To save foreign currency, materials such as concrete can be used for the local manufacture of fixtures for some domestic applications. These products are inferior to those discussed above, but they may be a realistic option. Ideally, concrete products should be designed so that angles, both internal and external, are rounded for ease of cleaning, and outlet pipes may be integrally cast into the body of the fixture. Concrete fixtures should be restricted to shower trays and baths, and possibly laundry fixtures such as troughs. It is recommended that concrete fixtures be cast in place wherever possible to eliminate the need for transportation. Concrete should not be approved for kitchen or food preparation sinks or benches. Local codes should cover all probable issues involving concrete fixtures, general design principles, etc., and also specify the proportions of sand, aggregate, cement and water required with general mixing, placement and finishing instructions. Preliminary investigations should ascertain the availability of

local materials of the appropriate quality to ensure that the products can be produced satisfactorily. Concrete products cannot be made completely impervious; surface treatments such as ceramic tiles are sometimes used to address this problem.

11. Design of plumbing systems

A plumbing system is a long-term investment and should be so designed that it does not become outdated and need replacement while its major parts are still serviceable. This requires careful estimation of current and future demand so that the correct capacity can be specified.

The capacity and dimensions of component parts in a plumbing installation should be adequate to meet both immediate needs and anticipated future use. However, perfection in design is frequently compromised by cost, especially in poor and developing communities.

Good design of plumbing systems is an important step in ensuring that the installations are efficient, safe and affordable. It should take into account the special needs and limitations of developing countries and should also ensure that the installations are appropriate for the different situations they serve. An understanding of the technical requirements and regulatory restrictions is vital for the provision of good plumbing services. This chapter includes design recommendations for plumbing installations in single dwellings, multiple dwellings and multi-storey buildings. It deals with special issues related to industrial and other special purposes, hot water and other dual supply systems and storm water drainage. It includes guidelines on capacities of plumbing systems, plumbing materials and products, and the use of protective devices to prevent back-siphonage and backflow.

11.1 Drinking-water supply pipes and specifications

Table 11.1 lists the typical unit water demands for the design of plumbing systems for various classes of buildings.

In each case the actual values will depend on local conditions, but no water service pipe should be of less than 20 millimetres (0.75 inch) diameter and all water service pipes should be laid so as to avoid high points where air may become trapped. Usually the water service pipe between the public main and the curb cock (the water authority's main water shut-off valve) at the boundary of the property belongs to the water authority, which assumes responsibility for its future maintenance, and the remainder of the service pipe is the responsibility of the owner of the property (in many cases, the responsibility of the water authority is extended up to the meter).

TABLE 11.1 TYPICAL DEMANDS FOR VARIOUS USES

Class of building	Consumption per day (litres)
Dwelling houses and apartments, per occupant	40–120
Industrial and commercial premises, staff sanitary facilities, per staff member	10–30
Addition per staff member, if showers or baths are provided	10–15
Motels, per occupant plus staff:	
With communal baths	100–200
With private bathrooms for each bedroom	200–400
Luxury hotels in the tropics	400–600
Hospitals, per bed, including catering and laundry	350–500
Nurses' homes and medical quarters, per occupant	115–150
Schools, per occupant plus staff:	
Day schools	15–30
Boarding schools	100–200
Cinemas, theatres, per seat	8–15
Restaurants, per seat plus staff	75–100
Laundries, per kg dry laundry:	
Hand operated	30–40
Mechanized	60–90
Airports, bus or railway terminals, per passenger catered for plus staff	15–45
Addition per passenger catered for, if showers or baths are provided	10–15

Source: Taylor & Wood 1982 (p. 55).

The depth at which the service pipe should be laid will depend on climatic and other circumstances. In areas subject to frost, the depth specified should be sufficient to avoid damage from freezing, and a depth of 1 metre (3 feet) or even more may be required. However, a maximum depth should be specified to facilitate future maintenance and installation procedures and to enable the pipe to be tracked if required. In tropical areas it is desirable that the incoming water should be kept cool, and a depth of 0.5 metres (20 inches) may be suitable. Where the ground is under cultivation, a depth of 0.8 metres (30 inches) should provide adequate protection. Distance requirements from other services such as electric, telecommunications and gas pipes should be specified. Under no circumstances should a service pipe be permitted to pass through a sewer, access chamber or inspection chamber. Table 11.2 shows the minimum diameter of water pipes needed to supply various types of plumbing fixtures.

11.2 Drainpipes

Each separately occupied building should have its own drain connection terminating at the public sewer. Such drains should be of adequate size, and laid at a constant gradient that will permit their contents to discharge at a self-cleansing velocity. Drains carrying human wastes need to have a diameter of at least 100 millimetres (4 inches) for a single dwelling and at least 150 millimetres (6 inches) if more than one property is served. Where a number of plumbing systems have

TABLE 11.2 MINIMUM INTERNAL DIAMETER OF WATER PIPES TO PLUMBING FIXTURES

Plumbing fixture	Minimum internal diameter
Drinking fountain, washbasin, water closet with flush tank	10 mm (0.375 inch)
Bathtub, domestic dishwasher, hose connection, domestic water heater, shower, sink, urinal with flush tank	15 mm (0.5 inch)
Commercial sink, urinal with flush valve	20 mm (0.75 inch)
Water closet with flush valve	25 mm (1 inch)

Source: Taylor & Wood 1982 (p. 60).

a single connection to the sewer, the plumbing authority may require a combined drainage agreement or other documentation to ensure that disputes do not arise over the apportionment of maintenance responsibility.

Although internal and external drains are often referred to as “horizontal”, they should never be laid level, but at a constant gradient that will ensure satisfactory drainage. A minimum velocity of 0.6 metres (2 feet) per second will prevent solids building up to block the pipe, and if the maximum velocity is limited to 3 metres (10 feet) per second this will prevent scouring and damage to the pipes. Table 11.3 shows the gradients at which these velocities are reached in pipes of various diameters and the approximate quantities that will be carried at such velocities.

TABLE 11.3 GRADIENTS TO PRODUCE MINIMUM AND MAXIMUM VELOCITIES IN DRAINS

Diameter of pipe		Minimum velocity 0.6 metres (2 feet) per second				Maximum velocity 3 metres (10 feet) per second			
		Grade		Carrying capacity per second		Grade		Carrying capacity per second	
mm	Inches	%	Litres	US gallons	UK gallons	%	Litres	US gallons	UK gallons
100	4	0.87	5	1.3	1.1	21.7	24	6.4	5.3
150	6	0.51	11	2.8	2.4	12.6	54	14.2	11.8
250	10	0.26	30	7.9	6.6	6.4	150	39.6	33.0
300	12	0.20	43	11.4	9.5	5.0	216	57.0	47.5

Source: Taylor & Wood 1982 (p. 59).

It may be necessary to use a pipe with a larger diameter if the relative levels of the building and the sewer are such that the appropriate gradient is inadequate to give a self-cleansing velocity for a particular size of pipe. However, a larger pipe will also have a tendency to lower velocity due to the fact that more of the water is in proximity to the frictional bed (contact surface between water and pipe). If the slope of the ground would cause the maximum velocity or gradient to be exceeded, the drain should be stepped, with the base of each vertical riser being adequately supported and the vertical section of the drain securely held in place. Such vertical sections can be more readily secured inside an access chamber.

12. Design of plumbing systems for single dwellings

12.1 General considerations

A single dwelling is a building designed for a single family or a group living as a family. It may be a house of one storey or more (whether detached or part of a terrace or block) or a self-contained apartment, and it has its own separate water and drainage connection. All pipes carrying either water or wastes should be watertight, durable and have a smooth and unobstructed interior. In order to avoid the risk of cross-contamination, the drinking-water supply from the water main and the drain connection to the public sewer should be separated. If for some reason water service and drainage pipes must be laid in the same trench, the water pipe should be laid on a firm shelf dug along one side of the common trench and should be at least 50 centimetres (20 inches) above the drain throughout its length, and both pipes should be laid with a minimum number of joints. Care should be extended to ensure that the water main is deep enough to prevent freezing in climates with low ambient temperatures.

Pipes need to be adequately protected against stresses caused by settlement or movement of ground where they pass into the building or under any interior wall. They should not be rigidly built into the structure, but should be separated by a layer of sand or flexible filler that can absorb stress due to unequal settlement.

The water service should be controlled by a corporation stop connected to the main by use of a special tool, which allows its installation without shutting off the public supply. The corporation stop is usually under the street or sidewalk and reaching the valve would require breaking the pavement. The incoming water service is further controlled by a curb cock typically situated near the point where the pipe crosses the boundary or property line. The curb stop is used to isolate the building from the main for repairs. It is normally placed in a box to allow easy access for opening and closing the valve. A long-handled wrench is the tool normally used to reach the valve. Where there is a serious risk of contamination of the public water mains by backsiphonage, this should be followed by a backflow prevention device. A stop shut-off valve should be located as close as possible to the meter and before any tappings or connections are made.

A drain cock should be positioned so that it allows emptying of all internal piping connected to the mains drinking-water supply. This system connection allows for drainage if the dwelling is left vacant for a period or if pipes need to be

modified or repaired. This is especially important in areas subject to frost. The drain cock should be easily accessible, and ideally it should be fitted with a hose connection to permit the drained water to be led outside the building. If fitted with a hose connection an approved backflow prevention device should be also installed.

12.2 Domestic storage tanks

There is considerable debate over the desirability in distributed water systems of domestic storage tanks or cisterns. An argument in favour of domestic storage is that it provides an air break that virtually excludes the possibility of back-siphonage and contamination of the public mains. Without this air break it is possible for contamination to occur whenever the mains pressure is reduced. In the event of temporary stoppage of mains supply (due to planned stoppages, breakdown or repairs), sufficient water is stored in the tank to provide domestic supply for a short period. The major disadvantage is that these tanks can become contaminated. Where distribution systems work without intermittency and the authority ensures a continuous positive pressure fixtures connected directly to the incoming water service pipe should be preferred, avoiding the need for a tank.

Tanks should always be covered by a close-fitting lid having an overlap to prevent its displacement, but not so airtight that air pressure can build up when the water level fluctuates within the tank (Taylor & Wood 1982). Those located below or at ground level are at special risk, as are those whose contents can be removed by dipping with a container. They should be inspected periodically and disinfected. Chlorine is frequently used but other approved disinfectants may also be effective.

In addition the pressure on plumbing fixtures remains constant despite fluctuations in the mains pressure. This is especially important where heaters or washing machines may be used.

An overflow pipe of at least 50 millimetres (2 inches) diameter must be fitted to every tank, and the tank and the overflow pipe should be fitted with insect screening. The internal diameter of the overflow pipe should be sized to accommodate the possible flow of water due to complete failure of the inlet valve. Possible restrictions caused by the insect screen should be taken into consideration. Enough space should be allowed to permit the water to rise to a height of at least twice the diameter above the top of the overflow without spilling. The ball valve inlet should be not less than 75 millimetres (3 inches) above the top of the overflow, thus providing an air break between the inlet pipe and the water in the tank.

The outlet(s) from the storage tank to the plumbing system should be taken from at least 50 millimetres (2 inches) above the floor of the tank, and should be controlled by a stop valve (or valves) at the first accessible point within the

dwelling. A separate drain should be set at the bottom of the tank and controlled by a valve to permit complete emptying of the tank. The diameter of the incoming service pipe should remain constant between the drain cock and the storage tank.

In a house with a pitched roof it is usual to locate the tank within the rafters, provided there is sufficient access to permit inspection, cleaning and repairs. For any roof mounting, the structure must be strong enough to carry the weight of the full tank. A full 500-litre (130 US gallons; 110 UK gallons) tank will weigh more than 500 kilograms (0.5 tonne). Sometimes it may be necessary to distribute the load by interconnecting two or more smaller tanks, but this should be avoided because of the potential that the water could stagnate (especially in the absence of residual disinfectant), thus causing excessive growth of heterotrophic bacteria (Bartram et al. 2003). If tanks are joined together, the inlets and outlets should permit a good throughflow of water to help delay or prevent stagnation. A single ball valve may serve to control the water level in both but each should have its own overflow pipe. In areas subject to extreme heat ($> 20\text{ }^{\circ}\text{C}$) or cold ($< 4\text{ }^{\circ}\text{C}$), tanks need to be insulated adequately. In a self-contained apartment it may be necessary to mount the tank near to the ceiling, such as inside an airing cupboard. A drip tray of adequate size below will collect condensation or leakage resulting from failure of the tank itself.

Some authorities may specify a standard tank size based upon the number of occupants and fittings, and the expected consumption per person (see Table 11.1). Thus, in an area where the daily water consumption is assumed to be 80 litres (20 US gallons; 18 UK gallons) per adult and 40 litres (10 US gallons; 9 UK gallons) per child, a dwelling capable of housing five adults would need a tank with a capacity of 400 litres (100 US gallons; 90 UK gallons). An apartment designed for two adults and one child would require a storage capacity of only 200 litres (50 US gallons; 45 UK gallons).

While tanks should be sufficiently accessible to permit maintenance, cleaning and adjustment of the ball valve when necessary, they should never be so placed that water can be withdrawn manually by the householder through dipping or ladling, because this would make it much more vulnerable to microbial contamination.

The sink tap connected directly to the main is doubly vulnerable to the possibility of water used for drinking or food preparation becoming contaminated within the building plumbing system. When this connection is permitted, it should be protected by an approved air gap or backflow protection device or an air gap between the outlet of the tap and the overflow level of the fixture or sink.

12.3 Domestic water closets

Table 11.2 lists diameters for connections from the water line or storage tank outlet to the various plumbing fixtures. Water closets should each be provided with a flushing cistern with an internal or external overflow controlled by a ball

valve or a similar device. Properly designed flushing cisterns deliver a fixed quantity of water in a short period, and refill at a steady rate through an inlet valve. The air break in the cistern provides an additional health safeguard.

Some authorities permit the use of flushometer valves instead of flushing cisterns for domestic water closets. However, these contribute to excessive water use. Pipes of a greater diameter are required to give a complete flush, and this may add to the cost. Flushometer or flush valves are also pressure and flow dependent and have maximum and minimum operating parameters. Overflows, normally at least twice the diameter of the inflow inlet pipe, should be taken through the wall to discharge outside. They should not discharge into the closet bowl because leakage often goes undetected. Overflow pipes should be located so as to provide a visible warning that the ball valve is not operating properly to cut off the incoming supply.

The inlet valve itself should be set higher than the top of the overflow pipe, the vertical separation being at least one and a half times the diameter of the overflow.

12.4 Wastewater traps

The outlet from every plumbing fixture should be trapped separately by a water seal device with a liquid seal of not less than 50 millimetres (2 inches) and not more than 100 millimetres (4 inches) in depth. Self-sealing waste valves may also be appropriate for this purpose. The pipe leading from the trap needs to have a diameter at least equal to that of the trap itself. The requirement that each plumbing fixture should be equipped with its own separate trap may be relaxed under certain circumstances, notably when combination fixtures are used, such as prefabricated units incorporating shower, washbasin, sink or other fixtures. It is sometimes allowable to install separate fixtures of this nature and combine the untrapped outlets into a single trap serving all. Under no circumstances should a water closet be part of such an arrangement; it is better to insist upon individual trapping. The amount of money saved by combining outlets is small, and the drains above the trap are more subject to clogging and the emission of foul odours due to the deposition of grease or soap on the wall of the pipe.

Sinks, washbasins and similar fixtures should incorporate overflows that discharge into the waste pipe below the stopper and above the outlet trap. Washbasins and similar fixtures may incorporate integral or attached overflows to discharge into the fixture waste pipe above the water seal of the trap and below the drain plug or stopper to the fixture. Sinks used in food preparation areas should not be fitted with overflows as they can become an entrapment area for food particles and a breeding ground for microorganisms and vermin. The outlet from a water closet should be not less than 75 millimetres (3 inches) in diameter.

Other domestic fixtures should have outlets of at least the following dimensions:

- washbasin, bidet or dishwasher: 32 millimetres (1.25 inches);
- sink or shower: 40 millimetres (1.5 inches).

Note: Some codes of practice require that a shower drain may not be less than 50 millimetres (2 inches) in diameter.

Each fixture should have a grille or strainer to prevent solids, such as hair and pieces of soap, from entering and choking the trap. The grille or strainer should be easily removed in case a child's finger becomes trapped.

12.5 Drains and ventilation pipes

The vertical ventilation or stack pipe is an essential feature of all plumbing systems. It prevents foul odours from the drain entering the building and also provides outlet to the open air. It also ensures that neither vacuum nor pressure can build up in the drainage system that might suck or blow the liquid seal from the fixture traps. There is no significant health difference between systems with exterior stacks and those with interior or concealed stacks. When plumbing is to be installed in existing buildings not already equipped with plumbing systems, installation may be simpler and less expensive if external stacks are allowed.

In some locations the most common method of installing the stack pipe in single dwellings is by mounting it outside against the exterior wall of the building. The weight of the pipe is supported at the lower end by a radius bend, set into a block of concrete adjacent to the building foundation. Its upper end is taken through or around the eaves (of a sloping roof) and extended upward at least 0.3 metre (1 foot). The water closet is located inside and adjacent to the exterior wall and its outlet carried through the wall to join the stack pipe at a junction fitting. Provision should be made to permit thermal movement between different plumbing materials, fixtures, pipes and fittings and the infrastructure of buildings into which such materials are installed. Of particular importance is pipework between fixed points that need to incorporate stress relief points and flexible joints to prevent failures to the plumbing system itself or the host structure.

The use of exterior stack pipes of this nature is not universal. In cold climates the danger of blockage or fracture from freezing prevents their use, and it may be necessary to keep all drainage within the building using a one-pipe system, as described later in this document. However, air admittance valves may also be used in primary or secondary ventilated systems, provided they are used within their application limits (see section 6.2.4). Exterior stacks may also be considered an eyesore, and the authority may require that the stack be installed within a wall where it cannot be seen except for the section that projects through the roof. An interior stack should be tested for not less than 15 minutes and visually examined to ensure that all joints are watertight prior to the application of the wall finishing material that will conceal the piping. This may be done by closing all outlets except the highest and completely filling the stack with water. If leaks are

detected, the water should be drained from the stack, the leak repaired and the system retested until no leaks are evident. If leaks do occur in concealed pipes, a foul odour may be the only indication that a pipe is not watertight or gasproof. Exterior pipes reduce the risk of leakage going undetected and are far more accessible if repairs are necessary.

As indicated earlier, the upper end of any type of stack should be at least 0.3 metre (1 foot) above roof level. If the roof is flat and accessible this height should be increased to at least 2 metres (6 feet). The stack pipe should be well clear of windows or fresh-air inlets, and should be protected by a wire cage to stop birds nesting in it. Where it is impossible to carry any internal stack above roof level it may be taken through the outside wall of the building and carried upwards to terminate at least 3 metres (10 feet) horizontally from or 0.75 metre (2.5 feet) above any window or other opening of the building or of any adjacent building. No vent pipe, either above the roof or through the wall, should be used for any other purpose, such as supporting an antenna, stay wire or other structural fixture.

Water closets should be connected to the horizontal drain leaving the building by the shortest possible route. For dwellings more than one storey high, the drain from a water closet on the upper floor should descend vertically, the upper part of this vertical pipe being carried upward to terminate in the open air above roof level. In single-storey buildings a vertical ventilation pipe should be carried upward from the top of the drain as close as possible to the outlet from the water closet. The connection of the water closet outlet to the stack pipe should be by means of a junction fitting. Where the water closet bowl is set on a rigid floor such as concrete, the pipe connecting it to the stack may be of rigid material with cement mortar or other solid jointing. Where the floor is of wood or other resilient material, either the pipe must be of plastic or of similar non-rigid composition or the joint between the bowl and the outlet pipe must be flexible, otherwise there is a danger of the bowl snapping.

Where in a single-storey building the stack is carried upward from the top of the water closet outlet pipe, the weight of the vertical stack must be either supported independently or a concrete base block must be provided to prevent deformation or crushing of the horizontal outlet pipe. At the bottom of the stack pipe a radius bend (to prevent clogging) leads the water closet outlet to the head of the horizontal drain connecting with the public sewer.

Outside the building at least one watertight inspection point or access chamber should be constructed; this should have a rigid cover capable of bearing any loads that it is exposed to. This access chamber serves several purposes:

- It gives an access point from which the drains can be inspected and rodded (both towards and away from the building).
- It provides a point from which tests can be applied to the drainage element of the plumbing system.

- It forms a junction into which the drainage from other plumbing fixtures may be brought to discharge into the horizontal drain. If more than one water closet is installed in the building the junction between them must also be made in the access chamber.

An additional access chamber should be constructed wherever there is a change of direction or gradient of the horizontal drain, a junction of two drains or a length of drain of more than 30 metres (100 feet).

When the two-pipe system with exterior stack pipes is used, the outlets from fixtures other than water closets should be carried outside the building and discharged into the horizontal drain at an inspection joint or access chamber. Relaxation of this condition is sometimes permitted where, for example, a single washbasin or similar fixture is to be connected directly to a stack or horizontal section of the drainage system within the building. In such cases a properly made fitting with no interior obstruction that might cause clogging should be used, and any connection to a horizontal section should be made at the top of the pipe. Clean-outs should be provided to enable all parts of the connection to be rodded.

Formerly it was considered necessary for an interceptor chamber, boundary trap or access chamber with a trapped outlet to be constructed at the last point on the property before the horizontal drain crossed the boundary. Some authorities still make this mandatory. Occasionally a fresh-air inlet is also required, but modern practice omits the need for this trap in the drain provided the plumbing system is ventilated as described above.

12.6 Connections to the public sewer

The wastewater drain should terminate at the public sewer where it is connected by a branch fitting or by a saddle jointed to the upper part of the pipe. The sewerage authority will often have its own regulations for jointing to the sewer. The actual jointing operation is frequently carried out by staff employed by the authority (the cost being charged to the owner of the building). In some cases the authority will construct the entire drain system from the property boundary to the sewer. Much will depend on whether the authority takes over ownership and responsibility for maintenance of this part of the drain. The plumbing code of practice should specify the respective responsibilities of authority and owner in this matter.

13. Design of plumbing systems for multiple dwellings

A multiple dwelling is a building housing several families or individuals in discrete units. The term includes apartment buildings, tenements, hotels, barracks, nursing homes and boarding schools. The common factors are that their prime purpose is for habitation, at least parts of their plumbing systems are in communal use and they are supplied by the normal pressure in the public mains.

The basic types of fixture will be the same as those dealt with under single dwellings – water closets, baths, showers, sinks and washbasins. However, other fixtures may be introduced, such as drinking fountains, laundry appliances and urinals. Health hazards are similar to those already described, but the risks are intensified by the possibility of cross-contamination of the drinking-water supply of one resident through the carelessness or unsanitary actions of another. Health precautions must therefore be similar to, but more stringent than, those already described for single dwellings.

The design of every plumbing system, and the capacity and dimensions of its component parts, should be adequate to satisfy immediate needs and those that can be reasonably anticipated during its expected life, based on the unit demands listed in Table 11.1. Whenever water flows in a pipe there will be some resistance to its flow as a result of its viscosity and also friction between the flowing water and the walls of the pipe. This resistance is related to the velocity of flow, the roughness of the piping material and the diameter of the pipe. In single dwellings the resistance to flow in water and drainage pipes will be very small, provided pipes of recommended diameters and materials have been installed. The pipework in multiple dwellings is more complex and resistance to flow must be taken into account when designing the system to accommodate the high rates of flow that will occur when several plumbing fixtures are being used simultaneously.

In a single dwelling, when a bath is being filled at the same time as a water closet flush tank only a minor reduction in flow will result. In a multiple dwelling there is a possibility that many different fixtures will be operated simultaneously, and this could have more serious effects: some fixtures may receive no water at all, and the drainage system may become temporarily overloaded. Various strategies can be employed to avoid this situation and are detailed elsewhere in this document. Any authority expecting that a number of multiple dwellings will be erected in its area of jurisdiction may well include one of these

design methods in its plumbing code of practice or simply make reference to the fact that special conditions apply to multiple dwellings.

13.1 Domestic storage tanks

The size of the water storage tank needed will depend on such factors as the capacity and pressure of the public mains supplying the building, the probability of an interruption of flow and whether a hot water and central heating system is to be installed. It is generally considered good practice to have sufficient storage for one day's consumption.

Water authorities usually specify the maximum height to which they can consistently supply mains water, and water storage tanks may not be necessary for buildings below the nominated height. However, where tanks are not installed an approved backflow prevention device should be provided in the incoming water service as near as possible to the stop valve within the building. The backflow prevention device prevents contaminants being introduced into the public mains by backpressure or backsiphonage. If a water tank for fighting fires is installed, it should not be combined with the domestic water tank. This precaution excludes the possibility of contamination of the domestic water storage.

13.2 Control valves

In multiple dwellings having units under separate occupation, control valves must be inserted into the drinking-water supply system to enable each separately occupied unit to be isolated from the remainder of the building. This permits repairs or maintenance to be carried out in one dwelling unit without interfering with the supply to other occupants. It also enables the water to be cut off in a temporarily unoccupied apartment. In buildings such as hotels or boarding houses, especially where water closets or bathrooms are used communally by a number of occupants, the need for separate control of each dwelling unit may be less, but there should be sufficient valves to control relatively small groups of fixtures or rooms.

Some authorities require each fixture to be controlled by a separate valve in multiple dwellings. This allows each fixture to be serviced or replaced without shutting off any other fixture and minimizes risk of negative pressure and backsiphonage whenever a substantial part of the system has to be shut down or emptied.

13.3 Waste systems

Drainage from a multiple dwelling may be designed on the one-pipe, two-pipe or single-stack principle. In the one-pipe system all wastes from water closets, sinks, baths and other fixtures are collected together and conveyed to the underground drainage pipes by common stacks. All branches are ventilated to

protect the traps from positive or negative air pressure. In the two-pipe system the wastewater pipes (carrying human sewage) and greywater pipes are kept separate and discharged outside the building into gullies. Wastewater from upper floors is conveyed to the gullies or trenches by vertical pipes from the fixtures and is carried to a back inlet gully. When vent pipes are omitted from the one-pipe system, it is called a single-stack system. In the single-stack system, the stack and the branches must be carefully designed to provide effective ventilation within the stack and branches. The one-pipe system may be necessary in very large and complex buildings or where there is the risk of frost damage.

The contents of wastewater pipes should be collected into vertical stacks, the lower ends of which are connected directly to underground drains. Junctions between drains from different stacks should be made in covered access chambers outside the building. If the numbers of drains is so large as to make junctions of this nature impracticable, two or more drains may be combined into suitably sized common drains. Each stack should usually be carried separately above the roof to form a vent, unless special conditions make it necessary to combine the upper ends of two or more stacks into a common ventilating stack. Careful planning of the building enables the number of stacks to be kept to the minimum by grouping the water closets close together, and one above the other in buildings of several storeys. The length of the outlet pipe between the fixtures and the stack should be kept to a minimum in every case. Many authorities require that the stack pipe is located outside the building for the reasons given in chapter 12. For buildings such as hotels, where a large number of rooms have individual water closets, it would be impracticable to locate all of these pipes on exterior walls, so a number of wells or shafts are often constructed within the building. They must be accessible for cleaning, as this is the only way to keep them clear of rats and cockroaches. Shafts must always be of sufficient size for repair work.

Fixtures other than those carrying human wastes should have their trap outlets carried to the open air through an exterior wall where they drain either directly to a gully or trench, or through a hopper head into a vertical pipe set over a gully or trench, the outlet from which is connected to the underground drain in an access chamber. However, it should be noted that hopper heads are no longer acceptable in the United Kingdom or Europe, due to the unsanitary implication of unhygienic water splashing directly to the atmosphere. Should the number of fixtures be so large as to make individual discharges of this nature impracticable, the outlets may be combined into suitably sized common outlets, discharging either to the open air as described or into stacks conveying waste-water only. When fixture outlets are combined in this way each outlet should be separately ventilated to protect against evaporation of the liquid in the trap seal.

Ventilation gases may be exhausted to the open air by means of ventilation pipes. These are separate short lengths of 25 millimetres (1 inch) diameter pipe – some codes of practice provide for a minimum vent pipe size of 40 millimetres

(1.5 inches) – terminating in a wire grating or mosquito gauze capping outside the exterior wall. Alternatively, the ventilation pipes from the fixture drains close to the downstream side of each trap may be combined and carried upward to a waste stack at a point above the highest connection carrying liquid waste to the stack.

14. Design of plumbing systems for multi-storey buildings

For plumbing purposes, the term “multi-storey” is applied to buildings that are too tall to be supplied throughout by the normal pressure in the public water mains. These buildings have particular needs in the design of their sanitary drainage and venting systems. Water main supply pressures of 8–12 metres (25–40 feet) can supply a typical two-storey building, but higher buildings may need pressure booster systems. In hilly areas, the drinking-water supply pressures will vary depending on the ground elevation. In these cases, the water authority may have to specify areas where particular supply pressures can be relied upon for the design and operation of buildings. Where a building of three or more storeys is proposed a certificate should be obtained from the drinking-water supply authority guaranteeing that the present and future public drinking-water supply pressure will be adequate to serve the building. If the public water pressure is inadequate, suitable means shall be provided within the building to boost the water pressure.

14.1 Systems for boosting water pressure

Pressure-boosting systems can be of several different types:

- pumping from a ground level or basement gravity tank to a gravity roof tank;
- pumping from a gravity storage tank or public water main into a hydro-pneumatic pressure tank that uses captive air pressure to provide adequate drinking-water supply pressure;
- installation of booster pump sets consisting of multiple staged pumps or variable speed pumps that draw water directly from a gravity storage tank or the public water main. Multistage booster pump sets typically include discharge pressure regulating valves to maintain a constant drinking-water supply pressure.

Written approval should be obtained from the appropriate authority before any pump or booster is connected to the supply. Where booster pump sets are permitted to draw directly from public water mains, the public drinking-water supply must be adequate to meet the peak demands of all buildings in the area. Otherwise, there is a high risk of backflow and subsequent contamination of the mains from buildings not equipped with a booster pump. Building booster

pumps are not a solution to the problem of inadequate drinking-water supply. Where public drinking-water supply systems are overburdened and cannot provide adequate pressure on a continuous basis, water must be stored on site during periods when adequate pressure is available to fill a gravity storage tank. The size of the storage tank will vary according to the daily water demand of the building, and the availability of adequate pressure available in the public water mains. It should not be excessively oversized to avoid stagnation due to inadequate turnover.

Multi-storey buildings can usually be divided into zones of water pressure control. The lower two to three storeys can generally be supplied directly from the pressure in the public water main. Upper storeys, usually in groups of five to eight storeys, can be supplied from pressure-boosted main risers through a pressure reduction valve for each group. Systems can be up-fed or down-fed. Up-fed systems usually originate from a pressure booster pump set or hydro-pneumatic tank in the basement of the building. Down-fed systems usually originate from a rooftop gravity tank. Where a building is divided into water pressure zones, care must be taken not to cross-connect the piping between two or more zones. This is a particular problem when domestic hot water is recirculated from a central supply system.

Where hydropneumatic tanks are used for storage, the tank is filled to one third to a half full by a float level device that controls the drinking-water supply source (a well pump or pressure booster pump). The pressure is maintained at the desired operating level by an air compressor. As the building uses water from the tank, the water level and air pressure drop. When the water level drops to the “on” setting of the float level control, the well pump or booster pump starts and raises the water level in the tank to the “off” level. This restores the pressure in the tank. If some of the captive air above the water has been absorbed by the water, the air compressor starts and restores the air charge, raising the system pressure to the normal level. Hydropneumatic tanks are typically made of steel or fibreglass and must be rated for the system operating pressure. Steel tanks must have a protective coating of suitable composition for drinking-water contact on the inside to protect the tank from corrosion and avoid contaminating the water. They should be checked on a regular basis to ensure that the protective coating is intact and the water remains potable.

Smaller hydropneumatic tanks can also be used to help control pressure booster pumps, allowing them to be cycled on and off by a pressure switch. The captive air within the tank keeps the system pressurized while the pump is off. When the water pressure drops to the “on” pressure setting, the pump starts and raises the volume and pressure of the water in the tank. No air compressor is needed where tanks have a flexible diaphragm between the air and the water in the tank, charged with air at initial start-up. The size of pressure tanks for booster pumps must match the capacity of the pump and the peak system

demand so that the pump “off” cycle is longer than the “on” cycle and the pump does not cycle too frequently.

14.2 Drainage systems

14.2.1 Drainage system considerations

In the drainage system for a multi-storey building, the drains from the plumbing fixtures are connected to vertical drain stacks that convey the waste and sewage to below the lowest floor of the building. The fixture drain traps must be vented to prevent their water trap seal from being siphoned by negative pressure or blown out by positive pressure in the drain piping. The fixture vent pipes must extend through the roof to outdoors. They can be run individually or be combined into one or more vents through the roof. Where buildings are over 10 storeys high, the drainage stacks require relief vent connections at specified intervals from the top, and connected to a vent stack that terminates above the roof. This relieves and equalizes the pressure in the drainage stack to maintain the water seal in traps serving plumbing fixtures.

Wherever possible, the sanitary drainage system from a building should discharge to the public sewer by gravity. All plumbing fixtures located below ground level should be pumped into the public sewer or the drainage system leading to the sewer. The pump line should be as short as possible and looped up to a point not less than 0.6 metres (24 inches) above ground level to prevent back-siphonage of sewage. The pump discharge rate should be controlled so as not to cause scouring of the internal bore of the pump line or the drainage or sewer system into which it discharges. High-velocity discharge rates may also cause the flooding of adjoining plumbing fixtures or overloading of the sewer itself. The sump pits for sewage pumps must have sealed covers, be vented to outdoors and have automatic level controls and alarms. Sewage pumps in multiple dwellings and in multi-storey dwellings should be duplex, with each pump having 100% of the required pumping capacity for the building. Alternatively, an approved vacuum drainage system may be considered.

14.2.2 Vacuum drainage systems

In a vacuum drainage system, the differential pressure between the atmosphere and the vacuum becomes the driving force that propels the wastewater towards the vacuum station. Table 14.1 provides a summary of the advantages and disadvantages of vacuum drainage systems. Table 14.2 provides information on specific installation and operation requirements. Vacuum drainage systems should be considered when one or more of the following conditions exist:

- water shortage;
- limited sewerage capacity;
- where separation of black water and greywater is desired;
- where drainage by gravity becomes impractical;

TABLE 14.1 ADVANTAGES AND DISADVANTAGES OF VACUUM SYSTEMS (VERSUS GRAVITY SYSTEMS)

Advantages	Disadvantages
Low installation costs	High component costs
Environmentally safe	Mechanical components – possibility of failure
Electrical power only required at vacuum station	Skilled design, installation and maintenance required
Always self-cleansing	Regular maintenance required
No possibility of vermin in pipelines	Standby facilities required
Possible water-saving technique if vacuum toilets used	Require area for situation of vacuum tanks and vacuum generation equipment
High water velocities prevent deposits in pipework	High-velocity water may cause transient plumbing noise
Minimal risk of leakage	
Can use small-diameter lightweight pipes that can be installed without a continuous fall	
Vertical lifts are possible	
Ability to easily separate greywater and black water	
High turnaround time – no need for cistern to refill for subsequent flushes	

TABLE 14.2 COMPARISON OF INSTALLATION AND OPERATION REQUIREMENTS OF DRAINAGE SYSTEMS

Parameter	Conventional (gravity)	Conventional (pumped)	Vacuum
Pipe size (mm)	Branches 32–100 Stacks 100–150	Branches 32–100 Stacks 100–150	Discharge from valves 32–50 Service connection 38–90
Pipeline gradient	To a fall	To a fall	Flexible arrangements, with minimal gradients or saw tooth profile. Vertical upward flow sections lifts can be used
Maintenance requirements	Negligible, only after abuse or blockage	Regular planned servicing of pumps and interface units	Regular, planned servicing of pumps and interface units
Energy requirements	At time of installation	At time of installation and throughout lifetime of building	At time of installation and throughout lifetime of building
Retrofit or extension of system within building	May be difficult to accommodate pipework and falls	May require additional pumps	Flexible layout makes installation simple
Conventional water consumption WCs	7.5 litre flush WC	7.5 litre flush WC	NA
Low water consumption WCs	6 litre flush WCs	6 litre flush WCs	1.5–3 litre flush vacuum toilets
Loading of sewerage system	Dependent upon appliances installed	Dependent on pumping rate	Discharge from forwarding pumps can be timed to coincide with low-flow periods

NA: not applicable.
Source: BRE 2001 (p. 3).

- in penal installations where isolation and control of the appliances is necessary to prevent concealment of weapons and drugs;
- unstable soil or flat terrain;
- where a high water table exists;
- in hospitals, hotels, office buildings or other areas where congested usage occurs, and flexibility in pipe routing is required to drain appliances;
- restricted construction conditions;
- building refurbishment.

When conventional gravity drainage systems are extended, as in refurbishment work, the existing gravity drainage system can be fed into the vacuum drainage system. This may be achieved by the use of a sump into which the wastewater from the gravity system drains. When sufficient water has accumulated in the sump, an interface valve will open allowing the wastewater to enter the vacuum drainage system. This arrangement can also be used to collect rainwater or as an interface between a building with conventional drainage and a vacuum sewer.

The collection arrangements and the small-bore pipework of vacuum drainage systems provide the possibility of easily separating greywater and black water. This would be of particular advantage if sewerage capacity was limited, as the greywater could be run to a watercourse after appropriate treatment.

14.3 Hot water and other dual supply systems

Dual drinking-water supply systems are those in which two different grades of water are available in separate piping systems. An example is the provision of a tap at a sink supplying water directly from the incoming water service while all other fixtures are fed from a storage tank. In developed countries, the most common is a secondary system of piping carrying hot water to sink, washbasin and bath. Occasionally a water softener is installed to treat part of a domestic system, but apart from these cases dual drinking-water supply systems are rarely found within single dwellings. An approach to water conservation being introduced in some communities is to recycle greywater to an outside tap for irrigation uses. A principal concern of all dual systems is the assurance that no cross-connections have occurred during installation or repair.

14.3.1 Hot water systems

Correct installation of non-return devices will prevent hot water from entering the cold water system in the event of an interruption of pressure. Regulations controlling the delivery of hot water from a hot water vessel may require tempered or thermostatically controlled water in all ablution areas, aged persons' homes, hospitals, schools and other public places, and use of thermostatically controlled mixing valves is encouraged where practicable. The acceptable temperature of hot water systems at the tap should be determined in concert with public health officials. To avoid scalding, especially of children, and in hospitals

and aged persons' homes, lower temperatures may be necessary. On the other hand, growth of *Legionella* organisms is reduced at temperatures above 50 °C, and this is a particular concern in hospitals and other large buildings such as hotels (see sections 3.1.4 and 3.3.1) (IPHE 2005).

Buildings such as hospitals, hotels, multiple dwellings and schools require large quantities of water to be heated, stored and distributed. Heating is usually carried out by a separate boiler, a steam coil or a heat exchange from a central heating or other system, and the temperature is normally controlled to within fairly narrow limits, 60 °C being an average temperature setting in some countries. Thermostatic devices should be installed to cut off the incoming heat source should the water in the storage vessel become excessively hot, and pressure relief valves should also be provided. Both these safety devices should be set in such a way that audible or visible warning is given whenever they come into operation. Heating and storage vessels should be clearly marked with their safe working pressure limits, and gauges should be fitted to enable a regular check to be made that those limits are being observed. Water heaters for the supply of hot water should always be installed strictly in accordance with the manufacturer's written instructions.

For reasons of safety, the water heater must be fitted with a combination temperature and pressure relief safety valve at the top of the unit prior to the commissioning of a mains or high-pressure water heater. To achieve this, a pressure relief safety valve must be fitted in the inlet or cold drinking-water supply pipework. The temperature and pressure settings of the respective safety valves should be specified by the manufacturer in accordance with the design capabilities of the specified water heater. The pressure setting for the pressure relief valve should be lower than the pressure setting for the combination temperature and pressure relief valve so that as the water heats up in the storage vessel and expands, the additional or excess volume is gently expelled from the lower and colder section of the water heater through the pressure relief safety valve. Where the available drinking-water supply pressure exceeds the upper limits of the pressure relief safety valve it is necessary to install a pressure reduction valve, appropriate to the pressure ratings involved, immediately after the isolation valve to the water heater and before the non-return valve. In some cases, it may be preferable to lower the drinking-water supply pressure to the whole system to avoid pressure imbalance in the hot and cold drinking-water supply systems. In these cases, the pressure reduction valve could be installed in the cold drinking-water supply pipework before it enters the building.

Low-pressure water heaters must not be pressurized beyond normal localized atmospheric conditions within the operating parameters of the manufacturer's specification. Equalizing the drinking-water supply pressure in a particular fitting (such as a shower) with the whole system is a little more complicated but it can be done by taking off a dedicated cold water service line from the

drinking-water supply tank to the heater unit. Depending on the capacity of the cold water distribution system, a separate supply tank may be required to avoid depleting the dedicated cold drinking-water supply tank serving the hot water system. The hot water system that is not considered potable should never be allowed to enter the cold water cistern (see section 12.2).

14.3.2 Other dual supply systems

Multiple dwellings and multi-storey buildings may have fire protection systems such as sprinkler variety systems or high-pressure mains and hydrants. Industrial and commercial establishments may have one or more systems of piping. These may carry cooling or process water from a secondary source or mains water that has been specially treated for the purpose.

When one component of the dual system has been derived from another source, or when it carries mains water that has been treated, heated or stored, it is essential that the non-mains component is not allowed to reconnect with the mains water. Drinking-water supply systems should be designed, installed and maintained so as to prevent contaminants from being introduced into the drinking-water supply system. Water of drinking-water quality should be supplied to plumbing fixtures or outlets for human consumption, bathing, food preparation and utensil or clothes washing. Where water supplied from one source is connected to another water source, an appropriate backflow prevention device should be fitted and the installation should be registered with the water supplier.

Systems that permit the introduction of any foreign substance into the water service should not be connected directly or indirectly to any part of the drinking-water supply system. This includes systems for fire protection, garden watering and irrigation, or any temporary attachment to the water service. This can only be done with backflow prevention and cross-connection control devices.

Combined tanks storing potable water alongside water for other purposes should have a double partition wall installed internally to separate the two supplies. The space between the partition walls should be arranged to ensure that any leakage cannot enter the other compartment of the tank. To achieve this, an external drainage point should be provided from the bottom of the void or space so that any discharge or leak is readily noticed.

14.4 Water storage vessels

Separate water storage vessels are an integral part of many dual supply systems. This section deals with requirements for the storage of water supplied from the water main or other drinking-water sources. In the design of these systems, it is important to ensure that the required air gap is established between the drinking-water supply inlet and the overflow spill level of the fixture.

Water storage tanks are appropriate for use in the following circumstances:

- sanitary flushing
- supply of drinking-water
- firefighting
- air-conditioning
- refrigeration
- ablutions
- prevention of cross-connections
- make-up water
- contingency reserve.

Requirements relating to installation and protection of water storage tanks:

- Tanks must be installed on bases, platforms or supports designed to bear the weight of the tank when it is filled to maximum capacity, without undue distortion taking place.
- Metal tanks (and other tanks when similarly specified) should be installed with a membrane of non-corrosive insulating material between the support and the underside of the tank.
- Tanks must be supported in such a manner that no load is transmitted to any of the attached pipes.
- Tanks must be accessible for inspection, repairs, maintenance and replacement.
- Tanks must be provided with a cover, designed to prevent the entry of dust, roof water, surface water, groundwater, birds, animals or insects.
- Insulation from heat and cold should also be provided.
- Tanks storing potable water should not be located directly beneath any sanitary plumbing or any other pipes conveying non-potable water.

Requirements relating to access to water storage tanks:

- Adequate headroom and side access must be provided to enable inspection, cleaning and maintenance of the interior and exterior of the tank.
- Where the interior depth of any storage tank exceeds 2 metres, access ladders of standard design should be installed and entry safety codes complied with.

Requirements relating to materials used in water storage tanks:

- The internal surfaces of tanks should be coated with a protective coating approved for drinking-water contact applied in accordance with the manufacturer's instructions if the tank is to supply drinking-water.
- Storage cylinders should be made of non-corrosive material.
- Tanks, pipes, heating coils and related fittings should all be of a similar metal to prevent electrolysis, which is more likely to cause corrosion in hot water systems than in cold.
- If steel is used for the tank and piping, it should always be heavily galvanized.

14.5 Labelling and colour coding of non-drinking-water supply systems

Where the alternative supply is a non-potable drinking-water supply, it needs to be clearly and permanently labelled “Caution – not for drinking” at every outlet. Exposed piping must be identified by colour coding (lilac) and permanent markings or labelling. The use of the lilac (light purple) colour on pipes and outlet points has been adopted in some countries to warn that the contents being conveyed within are not for drinking purposes. In the United Kingdom greywater colours are green-black-green, and reclaimed water pipe colours are green-black-green with an additional white band in the centre.

Where the non-potable alternative supply is installed below ground, the service should have a continuous marker tape stating that the pipe below is a “Non-potable drinking-water supply – not for drinking”. The marker tape should be installed in the trench immediately above the service. Where piping conveys water downstream from a high or medium hazard, the backflow prevention device shall be clearly and permanently labelled “Caution – not for drinking” along its length. To further assist in identification, outlet points or taps should be painted or coated lilac and a label or sign should be fixed or erected immediately adjacent stating “Caution – not for drinking”.

The level of potential cross-connection hazard rating should be classified by use of a method that allows easy identification of the risk level. A commonly used approach is to classify the contained fluids according to levels of risk from 1 (no risk or minimal risk) to 5 (highest risk).

Fluid category 1. Drinking-water supplied by the authority and complying with the plumbing code of practice.

Fluid category 2. Water in fluid category 1 whose aesthetic quality is impaired due to change in temperature or the presence of substances or organisms causing a change in taste, odour or appearance. This includes water in a hot water distribution system.

Fluid category 3. Fluid that represents a slight health hazard because of the concentration of substances of low toxicity. This includes any fluid that contains copper sulfate solution or similar chemical additives and sodium hypochlorite (as found in chlorine and common disinfectants).

Fluid category 4. Fluid that represents a significant health hazard because of the concentration of toxic substances. This includes any fluid that contains chemical or carcinogenic substances or pesticides (including insecticides and herbicides) and organisms that pose a potential risk to health at concentrations sufficiently above drinking-water standards or guidelines.

Fluid category 5. Fluid that represents a serious health hazard because of the concentration of pathogenic organisms or radioactive or very toxic substances.

This includes any fluid that contains faecal material or other human waste, butchery or other animal waste, or pathogens from any other source.

14.6 Situations where there is a risk of cross-connection

There are recognized risks of cross-connection in agricultural and horticultural properties, catering and allied trade installations, domestic installations, health and sanitary service installations, and in industrial and commercial installations. The level of protection required should be determined by identifying the hazards within the premises, then working upstream from each hazard. The water must be regarded as non-potable until a backflow prevention device is provided suitable to the degree of the rated hazard. If a cross-connection has been detected, the pipe system should be taken out of service, flushed, cleaned and disinfected, and the water tested and determined to be safe before it is put back into service. When assessing a potential backflow condition, consideration must be given to the complexity of piping, the possibility that the piping configuration has been altered and the possibility that negligent or incorrect use of equipment has resulted in a backflow condition. The following summarizes the main risks in each of these situations.

14.6.1 Agricultural and horticultural properties

In market gardens, poultry farms and dairy farms there is a risk of cross-connection between the water service and dam water, drinking nipples, fogging sprays, irrigation pipes, antibiotic injectors, cleansing injectors, vertical sprays for vehicle washing or any submerged outlet or hose at tanks or feed troughs.

14.6.2 Catering and allied trade installations

In commercial kitchens, hotels and clubs there is a risk of cross-connection between the water service and water-cooled refrigerant units containing methyl chloride gas or any submerged outlets or hoses that connect to glasswashers and dishwashers, bains-marie, food waste disposal units, garbage can washers, ice-making machines or refrigerators, or hoses supplying water to sinks or other receptacles.

14.6.3 Domestic installations

In domestic installations, there is a risk of cross-connection of the water service to a haemodialysis machine, bidet, water-operated venturi-type ejectors attached to garden hoses when used to empty or clean out wastewater pits, septic tanks, gullies or trenches, storm water sumps, domestic grease traps, or any submerged outlets, or discharge point of the water service in sanitary flushing cisterns, garden hoses supplying water to swimming pools, ornamental ponds, fish ponds, hose taps below the flood level rim of any fixture, or located below ground surface level.

14.6.4 Health and sanitary service installations

These installations include the following risks of cross-connection:

- council sanitary depots: cross-connection between the water service and sanitary pan washers, truck washers and pan-dumping machines;
- dental surgeries: any submerged outlets of the water service connected to chair bowls and venturi-type water aspirators;
- funeral parlours: in embalming areas, the cross-connection between the water service and water-operated aspirator pumps;
- hospitals and nursing homes: submerged outlets of the water service at bed pan washers, bed bottle washers, sterilizers, steam autoclaves, instrument washers, and any cross-connection between the water service and steam pipes, steam boilers or steam calorifiers;
- mortuaries: postmortem areas, submerged water service outlets at autopsy tables, flushing rim floor gullies or trenches, specimen tables and instrument-washing sinks.

14.6.5 Industrial and commercial installations

A common site of cross-connection relates to the use of tanks. Any submerged discharge point of hoses or pipes that supply water to rinse tanks, process tanks and other tanks may pose a cross-connection risk. The industries and commercial installations that carry a risk of cross-connection in these installations include the following:

- abattoirs: cross-connection between the water service and steam pipes, steam boilers or steam calorifiers, and the washing sprays in contact with animal carcasses;
- bleaching works: cross-connection between the water service and steam pipes, steam boilers, steam calorifiers, or any submerged outlets at revolving drum washers, or any pipes conveying non-potable water;
- breweries and cordial and soft drink plants: cross-connection between the water service and the contents of gas cylinders, steam pipes, steam boilers or steam calorifiers, or any submerged water service outlets at drum washers, bottle washers or process tanks;
- butcher shops: cross-connection between the water service and any water-cooled refrigerant units containing methyl chloride gas, or water-powered food-processing machines;
- chemical plants: cross-connection between the water service and chemical pipelines, or the submerged water service pipe outlets at drum washers and process tanks;
- dry cleaners: cross-connection between the water service and solvent stills;
- dyeing works: cross-connection between the water service pipes and steam

pipes, foul water inlet sprays in process tanks, and any submerged water service pipe outlets at vats, tanks and colanders;

- engineering works: cross-connection between the water service and any steam boilers, diesel oil recirculating systems, recirculated cooling water for machines, testing pressure vessels, oil-cooling coils, pump priming, compressed air pipelines and venturi-type ejectors in vehicle maintenance pits;
- laboratories: cross-connection between the water service and any aspirator pumps, fume cupboards, stills, centrifuges, blood-testing machines, air scrubbers, test-tube-washing machines, animal feeding troughs, and high-pressure gas cylinders;
- laundries: cross-connection between the water service and any clothes-washing machines, starch tanks, soap-mixing vats, and recirculated hot water tanks;
- milk-processing plants: cross-connection between the water service and any steam pipes, steam boilers, steam calorifiers, or any submerged outlets at bottle-washing machines, milk can-washing machines, and process chilling tanks;
- oil storage depots: cross-connection between the water service and foam firefighting equipment;
- poultry-processing plants: cross-connection between the water service and any steam pipes, steam boilers, steam calorifiers, or any submerged outlets at feather-plucking machines, carcass-washing machines, offal boilers and process tanks;
- photographic developers: cross-connection between the water service and X-ray equipment, or any submerged outlets at tanks and rinse machines;
- plating workings: cross-connection between the water service and solvent, acid or alkali tanks, cooling coils, steam pipes, or any submerged outlets at tanks and rinse machines;
- tanneries: cross-connection between the water service and vats, drum process tanks or steam pipes;
- wool processors: cross-connection between the water service and lanolin centrifuges and head recycling coils, or any submerged outlets or hoses at vats, drums and tanks.

14.7 Fixture unit calculations for multiple dwellings

The fixture unit concept is a method of calculating drinking-water supply and drainage piping requirements within large buildings where economies may be made in construction costs. Theoretically all pipes should be of such a size as to be capable of serving the fixtures to which they are connected when all other fixtures in the building are being operated at the same time. In practice, the chances of their simultaneous use are remote and the piping design criteria may be relaxed to some degree.

A fixture unit (f/u) value is assigned to each type of fixture based on its rate of water consumption, on the length of time it is normally in use and on the average period between successive uses. Some examples of fixture unit values assigned to the most common fixtures are given in Table 14.3. When these are added their total gives a basis for determining the flow that may be expected in a water or drainage pipe to which two or more fixtures are connected. The total is then reduced by a factor, usually in the order of 0.6 to 0.7, but depending upon the margin of simultaneous use protection necessary under local conditions (Taylor & Wood 1982).

The total number of fixture units connected to each branch pipe is then added, multiplied by the factor referred to above, and the result used to calculate the flow in water or drainage pipes in accordance with tables such as the following examples. If included in, or annexed to, a plumbing code, these tables should be detailed for a larger schedule covering the whole range of fixture unit values to be expected; examples may be found in various national codes.

TABLE 14.3 FIXTURE UNIT VALUES FOR SOME COMMON PLUMBING FIXTURES

Fixture	Fixture units
Bath or shower	2
Bidet	2
Clothes washer (automatic)	3
Drinking fountain	3
Kitchen sink	1.5
Urinal or water closet (with flush tank)	3
Urinal or water closet (with flush valve)	6
Washbasin	1

Source: Taylor & Wood 1982 (p. 153).

From Table 14.4 the size of the water pipes may be calculated using normal design principles (allowing for head loss, friction and other factors). Fixtures using both hot and cold water (such as in baths and sinks) should be assumed to take equal quantities of each for design purposes: a bath would be counted as one fixture unit on the cold water system, and one fixture unit on the hot water. Supply piping would be calculated accordingly, while the total figure of two fixture units would be used to design the drainage piping.

From Table 14.5 the size of internal and external drains may be calculated according to the total number of fixtures discharging into each section, with the proviso that underground drains shall not be smaller than 100 millimetres (4 inches) diameter, and that no internal branch or drain of less than 80 millimetres (3 inches) diameter should carry the discharge of more than two water closets.

An alternative to the fixture unit method for calculating flows is used in some French-speaking countries. This method assigns individual flow values to each

TABLE 14.4 PEAK WATER DEMAND OF PLUMBING FIXTURES

No. of fixture units	litres per second	US gallons per minute	UK gallons per minute
5	0.23	3.65	3.04
10	0.34	5.39	4.49
20	0.54	8.56	7.14
50	1.13	17.94	14.93
100	1.67	26.51	22.07

Source: Taylor & Wood 1982 (p. 153).

TABLE 14.5 MAXIMUM LOADS FOR HORIZONTAL FIXTURE BRANCHES AND BUILDING DRAINS OR SEWERS

Diameter of drainpipe		Fixture branch	Building drain or sewer			
mm	inches		Min. slope 2% (1 in 50) f/u ^a	Slope 0.5% (1 in 200) f/u ^a	Slope 1% (1 in 100) f/u ^a	Slope 2% (1 in 50) f/u ^a
32	1.25	1	—	—	—	—
40	1.5	3	—	—	—	—
50	2	6	—	—	—	26
65	2.5	12	—	—	—	31
80	3	32	—	36	42	50
100	4	160	—	180	216	250
150	6	620	—	700	840	1000
200	8	1400	1400	1600	1920	2300

^a f/u = fixture units.

Source: Taylor & Wood 1982 (p. 154).

fixture, multiplies the cumulative flow so obtained by a simultaneous use factor obtained from a nomogram and curve, and selects pipe sizes by reference to precalculated tables.

15. Design of plumbing systems for industrial and temporary applications

15.1 Backflow prevention in industrial, commercial and institutional water systems

Any water piping installation where there is a possibility that a harmful substance may gain access to a drinking-water supply must have a backflow protection device installed. Various types of backflow protection are described in this chapter. This topic is addressed in considerable detail in the *Cross-connection control manual* (EPA 2003). Following are some examples of installations that require backflow protection devices:

- irrigation and watering systems where harmful chemicals can be siphoned back into the drinking-water supply system;
- boilers and cooling towers where harmful water treatment chemicals can seep into the drinking-water supply system;
- faucets that are installed below the overflow rim of bathtubs, sinks and lavatories or other plumbing fixtures;
- water connections, water closets, urinals;
- faucets and make-up lines to open tanks;
- automatic drink-vending machines where there is a need to prevent carbon dioxide gas from getting into the drinking-water supply system;
- hospitals, mortuaries and industrial facilities;
- swimming pools and spa make-up water;
- connections to private drinking-water supply systems;
- locations where drinking-water supply hoses can be placed in contaminated water or sewage.

Dangers associated with hose connections are more insidious because precautions against contamination depend on the user rather than the installer and consequently are much more difficult to control.

15.2 Backflow and backsiphonage

Backflow is an unwanted flow of potentially contaminated water, used water, industrial fluids or other substances from any domestic, industrial or institutional piping system into a drinking-water system. The flow under these conditions is in the reverse direction from that intended. Backflow is caused by a reverse pressure gradient that, if not interrupted, will cause a flow of water back into the

drinking-water system. This is sometimes referred to as a vacuum, which in these circumstances means a pressure below that of the atmosphere. So in a water distribution system a true vacuum is not necessarily the cause of backflow of fluids; a small difference of pressure is all that is necessary to cause the reversal of flow in any pipeline.

Backsiphonage is an undesirable or reverse direction of flow caused by atmospheric pressure differentials exerted against a pollutant liquid, forcing it towards a drinking-water supply system that is under a lower pressure. When fluid is siphoned out of a container through a piece of tubing, the fluid will flow up and over the rim of the container and then down into a lower elevation. In a dangerous cross-connection, unwanted fluid may be sucked over into the drinking-water line. It is not necessary for a true vacuum to exist in the system main for this siphonage to occur; all that is required is a negative difference in pressure and a section of tubing or pipe that is completely full of fluid.

15.3 Water system backflow protection devices

Protective devices are installed in order to minimize risks associated with the operation of drinking-water supply and domestic sewerage systems. A vital role of these devices is to prevent backflow or backsiphonage into the mains drinking-water supply. This section describes the nature and operation of the most common protective devices. The diagrams of the devices are from the *2000 Uniform Plumbing Code illustrated training manual* published by the International Association of Plumbing and Mechanical Officials (IAPMO 2000).

Air gap. This is a physical separation between drinking-water (the mains drinking-water supply system) and other fluids.

Atmospheric or non-pressure-type vacuum breaker. This device is always installed downstream from the shut-off valve. The air vent valve closes when water flows in the normal direction. As soon as the water ceases to flow the air

FIGURE 15.1 ATMOSPHERIC VACUUM BREAKER

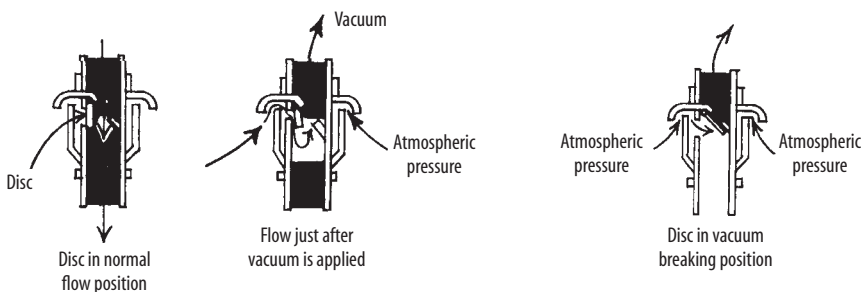

Source: IAPMO 2000 (p. 6).

FIGURE 15.2 ATMOSPHERIC VACUUM BREAKER (NORMAL FLOW AND BACKFLOW CONDITIONS)

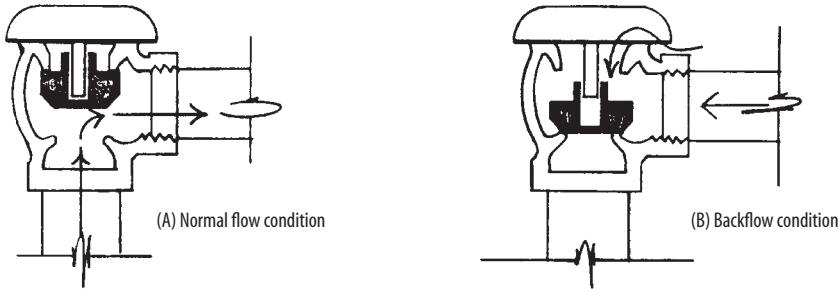

Source: IAPMO 2000 (p. 7).

vent valve opens, thus interrupting any possible backsiphonage effect (Figures 15.1 and 15.2). No hose should be attached to the device and run to a point of higher elevation because the weight of the water in the hose will keep the relief valve closed and the device will not provide the intended protection.

CASE STUDY 3. CHLORDANE BACKFLOW OR BACKSIPHONAGE

Approximately 11 litres of chlordane, a highly toxic insecticide, was sucked back (backsiphoned) into the water system of a residential area of a city. Residents complained that the water “looked milky, felt greasy, foamed and smelled”. The problem developed while water department personnel were repairing a water main. Meanwhile, a professional exterminator was treating a nearby home with chlordane for termite elimination. The workman for the exterminator company left one end of a garden hose that was connected to an outside hose bib tap in a barrel of diluted pesticide. During the water interruption, the chlordane solution was backsiphoned from the barrel through the house and into the water main. Fortunately, due to the obvious bad taste, odour and colour of the contaminated water, no one consumed a sufficient quantity to endanger health.

Source: Adapted from EPA 2003 (p. 8).

Double check valve assembly. This consists of two internally loaded, specially designed operating check valves. This assembly is fitted with a tightly closing shut-off valve upstream and downstream of the check valves (Figure 15.3).

Pressure-type vacuum breaker. This device is designed to open with the aid of a spring when the line pressure drops so that air will break a potential vacuum. It includes a single check valve that closes at the cessation of normal flow (Figure 15.4).

FIGURE 15.3 DOUBLE CHECK VALVE ASSEMBLIES

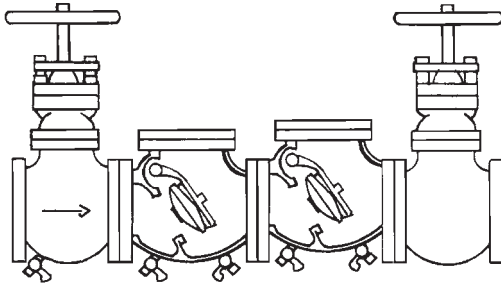

Source: IAPMO 2000 (p. 10).

FIGURE 15.4 PRESSURE VACUUM BREAKER

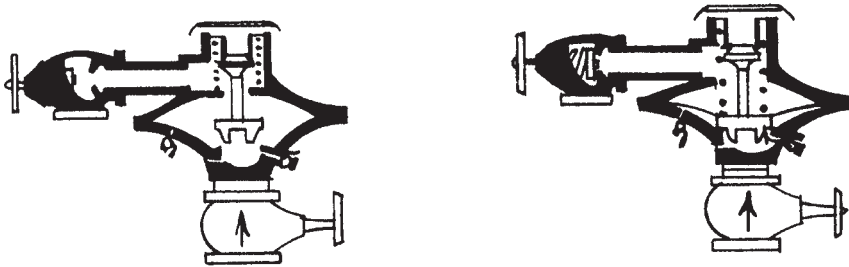

Source: IAPMO 1997 (p. 176).

CASE STUDY 4. BACKSIPHONAGE FROM A HOSE

The water system of a small town had been contaminated with caustic sodium hydroxide. Residents were covered with tiny blisters after showering in their homes. One person complained of blisters on her head after she washed her hair and others complained of burned throats or mouths after drinking the water. Several persons received medical treatment at the emergency room of the local hospital. A possible source of the contamination was from a nearby chemical company that distributes chemicals such as sodium hydroxide. The sodium hydroxide is brought to the plant in liquid form in bulk tanker trucks and is transferred to a holding tank and then pumped into 208-litre drums. While washing the truck's tank, the driver was adding the water from the bottom of the tank truck instead of the top, when the water main broke and sodium hydroxide back-siphoned into the water main (Figure 15.5).

Source: Adapted from EPA 2003 (p. 3).

FIGURE 15.5 BACKSIPHONAGE ILLUSTRATION

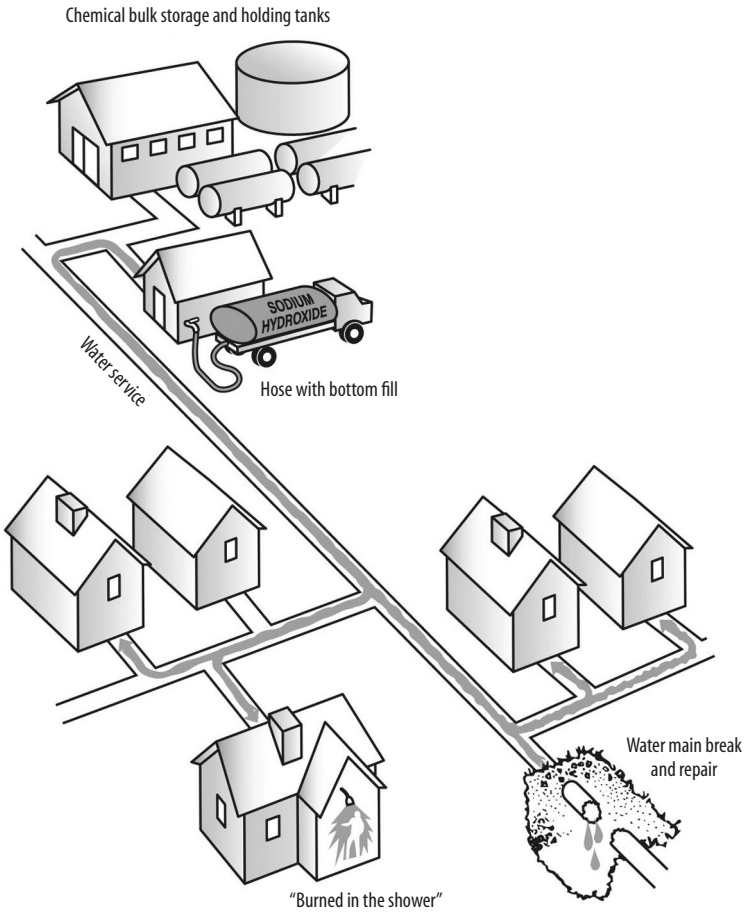

Source: EPA 2003 (p. 3).

Reduced pressure principle device. This is an assembly of two internally loaded, independently operating check valves, with a relief valve between the valves. It is specifically designed to maintain a zone of reduced pressure between the two check valves at all times, and has a tightly closing upstream and a tightly closing downstream shut-off valve (Figure 15.6).

FIGURE 15.6 REDUCED PRESSURE PRINCIPLE BACKFLOW PREVENTER

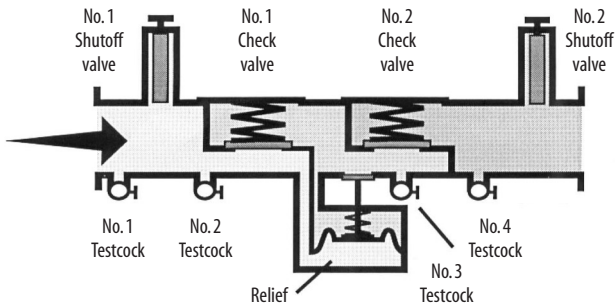

Source: IAPMO 2000 (p. 12).

CASE STUDY 5. SHIPYARD CROSS-CONNECTION

The drinking-water system at a coastal shipyard became contaminated from incorrectly connected water lines between ships at the pier and the shipyard. The cause of the problem was a direct cross-connection between the on-board saltwater fire protection system and the freshwater line connected to one of the ships at the dock. As a result, the on-board saltwater fire protection system, being at a greater pressure than the potable supply, forced the salt water, through backpressure, into the shipyard potable supply (Figure 15.7).

Source: Adapted from EPA 2003 (p. 7).

Devices to protect sewerage systems. This category of devices aims to limit unwanted contamination of domestic sewage outflow and to protect the environment. Where possible, reclamation of useful waste materials for recycling should be attempted. A large number of specialized protective devices of this nature are now commercially available. Many of these promise to be more efficient in the long run than the traditional devices illustrated here. The illustrations for the grease trap, grease interceptor and grease and sand interceptor are diagrammatic only. The size and design of these devices or apparatus is dependent on the nature of the material to be treated, its temperature, the anticipated flow rates involved and numerous other factors.

FIGURE 15.7 SHIPYARD BACKFLOW CONTAMINATION

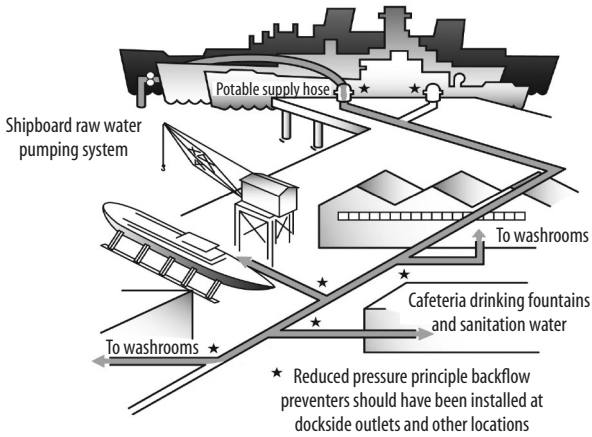

Source: EPA 2003 (p. 7).

Grease trap. This device is installed inside the facility, usually near the grease-producing fixtures (Figure 15.8).

FIGURE 15.8 GREASE TRAP

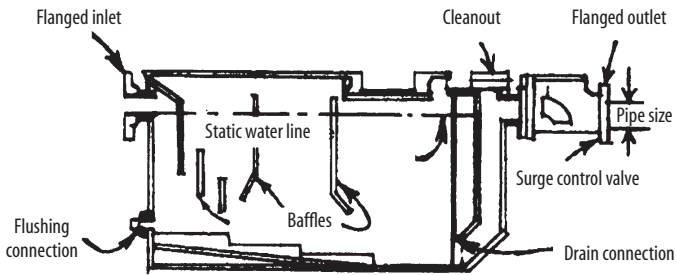

Source: IAPMO 2000 (p. 16).

Grease interceptor. This type of device is usually installed outside the building (Figure 15.9).

FIGURE 15.9 GREASE INTERCEPTOR

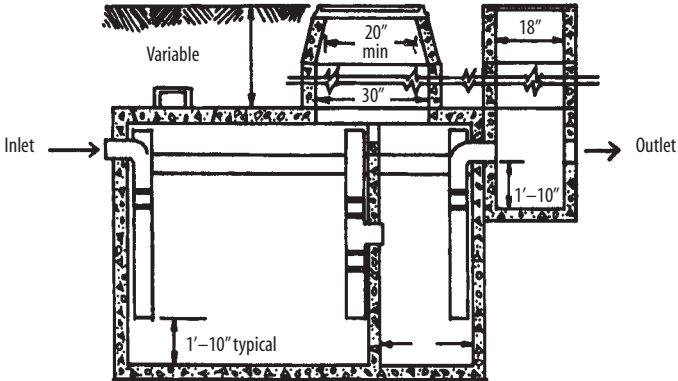

Source: IAPMO 2000 (p. 18).

Sand and oil interceptor. This device is used to prevent sand and oil from parking areas getting into sewers or storm sewers (Figure 15.10).

FIGURE 15.10 PRECAST CONCRETE SAND AND OIL INTERCEPTOR

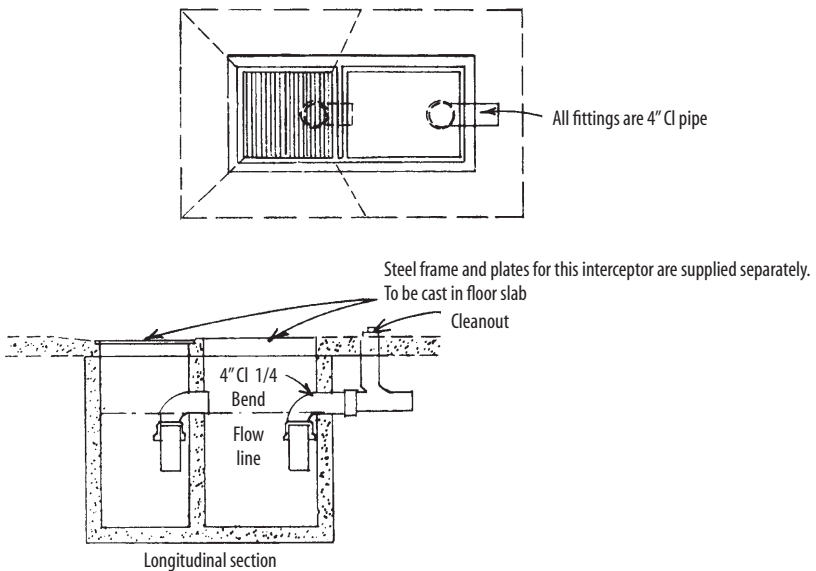

Source: IAPMO 2000 (p. 21).

15.4 Guidance for protective devices

Backflow prevention devices are classified as testable or non-testable for the purposes of regulation. These devices can also be classified according to the level of hazard involved.

15.4.1 Testable devices

Requirements for reduced pressure zone devices – high hazard:

- must have free ventilation to the atmosphere for the relief valve outlet at all times;
- must not be located in an area that may be subject to ponding;
- must have the relief drain outlet located not less than 300 millimetres (12 inches) above the surrounding surface;
- must be located so as not to be subject to freezing;
- must be tested and certified every year.

Requirements for pressure-type vacuum breakers – medium hazard:

- must be located not less than 300 millimetres (12 inches) above the highest outlet;
- must be ventilated to the atmosphere at all times;
- must not be located in an area that may be subject to ponding or freezing;
- must be tested and certified every year.

Requirements for double check valves – medium hazard:

- must be located so as not to be subject to freezing;
- must be tested and certified every year.

Testable devices should be tested annually to ensure they are operating properly. The drinking-water supply authority or company should be able to register and monitor all such devices using an inspection and maintenance report system.

15.4.2 Non-testable devices

Non-testable devices include atmospheric vacuum breakers, hose connection vacuum breakers, vented double check valves, dual check valves, dual check valves with atmospheric vent and single check valves. Non-testable devices do not require annual reports. However, they should be regularly checked by the owner-occupant to ensure that they are operating correctly.

Requirements for atmospheric vacuum breakers:

- must be located not less than 150 millimetres (6 inches) above the highest outlet;
- must have no isolating valves located downstream of the vacuum breaker;
- must not remain continuously pressurized for more than 12 hours in normal operation;

- must be ventilated to the atmosphere at all times;
- must not be located in an area that may be subject to ponding;
- must be located in line, and be at least the same size as the supply and discharge piping.

Requirements for hose connection vacuum breakers:

- must be located downstream of the isolation valve;
- must not remain continuously pressurized with the water for more than 12 hours in normal operation;
- must be ventilated to the atmosphere at all times.

Requirements for vented double check valves:

- must not be located in an area that is subject to ponding or freezing;
- must have the vent port located not less than 300 millimetres (12 inches) above the surrounding surface so that the device is freely drained.

Requirement for dual check valves:

- must be located in an area not subject to freezing.

Requirements for dual check valve with atmospheric vent:

- must not be located in an area that is subject to ponding;
- must have the vent port located not less than 300 millimetres (12 inches) above the surrounding surface so that the device is freely drained.

Requirements for single check valve:

- must have an isolating valve installed upstream and adjacent to the device;
- must be fitted in an accessible location;
- must only be used in fire services.

Note: Single check valves are not deemed to be backflow prevention devices.

15.5 Guidance for sanitary waste systems

All human and domestic waste must be discharged to a public sewer, or a private sewage disposal system containing a septic tank and proper seepage pits or disposal field. Untreated human or domestic waste must not be discharged direct to the ground or into waterways. All sanitary waste systems, whether discharged to a public sewage treatment facility or to a septic tank and disposal system, should contain domestic sewage only. All other waste should be pretreated or processed. The following guidelines should be observed:

- Industrial waste should be pretreated to remove harmful chemicals and heavy metals from the waste stream. The governmental authority should specify the pretreatment requirements.
- Restaurants should have kitchen waste discharged through a grease trap or grease interceptor to remove grease from the sanitary sewer.

- Swimming pools, cooling towers and water displays should discharge into the sanitary sewer instead of the storm sewer.
- Rainwater surface flows that become contaminated by contact with oil, grease or harmful chemicals should be pretreated if possible prior to being allowed to discharge into the storm sewer or waterway.
- Industrial or laboratory waste discharge that may change the pH of the sewer system must be pretreated to neutralize the industrial waste stream so it does no harm to the waste treatment operation.
- Nothing should be admitted into the public sewer that could damage, choke or clog the pipes, produce a flammable or explosive mixture, constitute a danger to the public or the authority's workers or interfere with the sewer treatment process.

The sewer authority should consider the following factors when deciding whether to accept an industrial waste:

- What is the relation between the quantity of the effluent to be discharged and the quantity of sewage with which it will be mixed? If the effluent is diluted sufficiently it may be less harmful.
- How complex is the process of treatment and what space and facilities are available at the factory site?
- Are there other industries in the neighbourhood producing similar waste? There may be arguments in favour of combining the outflows and treating them together.

Some sewer authorities base their charges for receiving and disposing of industrial waste on the quantity received and on the degree of treatment necessary. This encourages larger factories to install their own treatment plants. However, smaller companies may be unable to do this because of lack of space or of capital. In areas where a particular industry is important to the community, it may be better for the authority to accept waste and charge accordingly. When dealing with commercial waste, the authority will also have to be guided by the nature, quantity and strength of the effluent before deciding whether to receive it untreated into the public sewers. Premises such as slaughterhouses, breweries and dairies may at particular times discharge quantities of highly oxidized waste that can upset the biological process at the disposal works unless special precautions are taken. Under certain circumstances it may be necessary to require that the waste is diverted to a holding tank and released at a steady rate over a specified period of time rather than in sudden rushes or large batches.

15.6 Storm water drainage systems

Only clear, clean uncontaminated storm water drainage should be allowed into a storm water drainage system or discharged into local waterways. Storm waters containing deleterious substances should not be discharged into watercourses or

surface water drainage. They must either be taken to the public storm sewer, or must be treated on site to remove the offensive pollutants. These requirements may, however, be incompatible in industrial and similar premises. For example, rainwater falling on roads and paved areas should be separated from sewage to prevent overloading of the sewerage system. It should be discharged to a ditch or watercourse. However, if chemicals, oil or other spillage on the road is washed into the watercourse, serious damage to fish and other wildlife may result. Therefore, precautions should be taken to divert the initial flow into the sanitary sewer and the overflow then can be discharged to the storm water drainage system.

15.7 Temporary plumbing installations and connections

A plumbing hazard that is particularly difficult to control is a temporary installation for a particular purpose. Backflow and backsiphonage devices should be installed as described in sections 14.5 and 15.3. Because these temporary installations are not part of a plumbing system or connected to conventional fixtures, they are not subject to the requirement of plans submission, but they should be subject to other controls. Such temporary installations can be more dangerous than permanent systems, especially when they are not subject to the plumbing code of practice construction and use requirements.

15.7.1 Temporary connections on building sites

One common purpose for a temporary connection is for provision of water during building construction. Hoses from standpipes on building sites commonly deliver water into tanks of muddy water. A drop in mains pressure could siphon the contents back into the public system. Hoses may also connect standpipes to concrete mixers and provide water for various building processes. Temporary latrines may be constructed with defective sanitary fixtures that are illegally connected to the main.

15.7.2 Other temporary connections

Hoses or other temporary piping may constitute a danger in other circumstances, such as at a petrol garage (gas station), farmyard, fairground, commercial garden or pesticide applicator (especially when coupled to an insecticide sprayer), or when cleansing a market or the interior of market vehicles. The plumbing approval would cover the permanent system, possibly including a legitimate external tap to which a hose may be connected, but normally the use of the hose is not covered in the code of practice. One safeguard is an agreement between the water authority and the owner that should specify the purpose of the hose or temporary piping and assess the payment for the water used. Rules for sanitary usage may also be incorporated into the permit or agreement.

All the water piping downstream of backflow protection devices is normally classified as an industrialized water system. To protect workers from taking this water for domestic use, each outlet in such industrialized water systems should be clearly marked “Industrial water – do not drink”.

Most widely used model plumbing codes of practice specify the use and type of backflow prevention devices for specific applications. While every potential cross-connection scenario cannot be covered by the plumbing code of practice, the defined governing principles protecting the drinking water system are usually specified.

When writing a plumbing code of practice the authority should carefully assess the applications of backflow protection devices to be expected in their area together with any special hazards associated with them. The plumbing code of practice can be framed comprehensively but without being overloaded with inappropriate material. It is often better to restrict the code to basic principles and reserve the right of the authority to impose conditions in special circumstances, rather than attempting to cover every possible situation in detail.

16. Storm water drainage

There are three principal ways to dispose of rainwater from roofs, courtyards and paved areas: storm water sewers, soakaways and collection in storage tanks. Storm water sewers, which may in some cases consist of open channels, are more common in urban or densely built-up areas, and they normally serve to take the drainage from highways as well as from buildings.

16.1 Discharge into storm water channels or pipes

Where a storm water pipe or ditch exists within reasonable distance of the property on a building site, the drainage from the roof and from any paved or enclosed areas must be collected and discharged into the storm water pipe or ditch. In many cases, the ditches or channels are laid alongside the road just outside the boundary of the property and are the responsibility of the highway authority, which may have its own connection requirements that should be incorporated into the plumbing code of practice. For piped sewers, any connecting drains will need to comply with requirements similar to those that apply to drains carrying wastes to the soil sewer. The saddle or junction connection must be made under the direction of a licensed plumber or qualified person and must not obstruct the flow of the sewer or the drain. The drain itself must be laid to a self-cleansing gradient and must be properly jointed to prevent the access of tree roots or of the surrounding soil. However, the materials may not need to be of as high a quality and the drain may not need to undergo a test for watertightness.

Discharges into an open drainage channel may be through a pipe or through a subsidiary channel. Care must be taken to prevent erosion and damage to the channel lining. Subsidiary channels and pipes will usually be required to discharge in the direction of flow of the main channel at a level above that of the normal drainage flow. If the main channel is unlined and the discharge into it is through a pipe, a protective concrete apron may be required at the point of discharge. Subsidiary channels should be laid to a self-cleansing gradient, but this, together with requirements relating to diameter, may be modified according to soil conditions.

Discharges into storm water sewers or channels must not contain any human waste, sullage water or other substances that may cause a nuisance or injury to health. In tropical countries having a long dry season, small discharges, such as a drain from a single tap, may increase the risk of infestation because protozoans

or other parasites may breed in shallow pools or waterlogged ground. Where a channel or drain may remain virtually dry for perhaps months at a time small discharges may cause considerable nuisance, especially if they contain deleterious matter such as oil or grease. The authority may make special provisions to avoid this by requiring that a paved area where cars might be washed should be provided with a petrol, sand or oil trap and plate separator.

These dangers must be balanced against the desirability of dealing with clean water discharges without requiring their being connected to human waste sewers. Such instances as the drainage from air-conditioning units and of cooling water from a dairy or small industry, or the hosing down of a warehouse floor, should not call for disposal treatment, but the volume of water may be too great to be dealt with by soakaways.

16.2 Combined sewers

Some sewerage authorities operate systems of combined sewers into which both sewage and rainwater may be admitted. These systems were installed in the past but are not currently recommended. Combined sewers are not economical because much greater flows must be provided for in the sewers and in the sewage disposal plant. These systems are also hazardous to health because storm overflows must be provided to handle heavy downpours. Those overflows are necessary to relieve surcharge of the system at peak flows, and they may permit untreated sewage waste to discharge into open watercourses.

Combined sewers are rarely installed today, but they are often found in congested areas of older cities where physical and financial constraints may prevent the laying of a second system of pipes to carry off rainwater. Wastewater authorities provide separate sewerage facilities for new developments, as every additional connection to a combined sewer makes its ultimate replacement more difficult and expensive.

16.3 Soakaways

Rainwater from sloping roofs must be collected in gutters and carried to ground level by downpipes or downspouts. Flat roofs should be drained by vertical pipes and the drainage should be conveyed by pipe to a surface water sewer or to a suitable soakaway. Except when a roof is thatched, gutters and downpipes or downspouts should always be considered essential because they prevent roof runoff falling from a height in concentrated sheets or streams, which can cause erosion close to the foundations of the building. If guttering cannot be installed a concrete path or apron should be laid immediately under the eaves, and should be sloped to carry the water away from the foundations.

The sizes of gutters and downpipes or downspouts will depend on the area of roof to be drained, the slope of the gutter and the intensity of rainfall expected. To insist on guttering capable of dealing with the worst storms would be

unreasonably expensive in many areas, and would be of little overall benefit when the entire surrounding ground was being subjected to a downpour. The authority should calculate the average storm intensity expected and fix their standards accordingly. Tables 16.1, 16.2 and 16.3 relate roof area, guttering slope and storm intensity (Taylor & Wood 1982). These tables can be adapted to suit local conditions. The capacity of a range of storm water drains is also shown, and may be applied to the drains connecting the lower ends of the downspouts with the surface water sewer.

Whether or not the use of soakaways is a practical option will depend to a great extent on the nature of the soil. Soakaways should be well clear of the building foundations, and should consist of holes deep enough to penetrate the subsoil, filled almost to the surface with hard material such as broken stone, concrete or brick that will not soften when wet. Where the water table is high, it may be preferable to use shallow ditches filled with hard rubble instead of soakaway pits.

16.4 Rainwater tanks

When rainwater is being stored for domestic use the tanks should be of watertight construction, covered with material that is weatherproof, insectproof and verminproof, ventilated, and supplied with access for regular inspection and cleaning. There are many standards throughout the world. For more technical detail on this subject, please check your area for its standards. Rainwater storage tanks are a valuable supplement to mains supplied in arid areas and may even substitute for a mains supply. A system of gutters and collector piping must also be watertight, and the contents must be protected against pollution from dust and refuse blown by the wind, entry by birds and vermin, and mosquito breeding. If the rainwater is supplementary to a mains supply it may be lifted from the principal storage tank via a pump, from where it is piped to all fixtures. If there is no mains drinking-water supply then water for all purposes will need to be taken from the rainwater storage tank. Strict precautions should be observed in such cases to maintain the quality of the stored water. A wash-out drain tap or diverter should be included in the collector pipe so that the first washings of the roof at the beginning of the rains can be run to waste (these washings will be contaminated with bird droppings, windblown dust, etc.). It is at this time that the storage tank should be given its annual cleaning, a process that is much easier if the tank is built in two sections that can be emptied and cleaned in turn.

16.5 Rainwater intensity and roof drainage

The variable factors in selecting the size of rainwater guttering are:

- the anticipated intensity of the rainfall;
- the slope at which the gutters are to be fixed;
- the area of the roof surface drained by each gutter.

From a practical point of view an upper limit of rainfall intensity must be assumed. During downpours of higher than the assumed concentration, surplus rainwater will overflow the guttering but will add comparatively little to the general deluge. In Tables 16.1, 16.2 and 16.3 the maximum intensity has been assumed to be 100 millimetres (4 inches) per hour – a high figure. In the code the figures would be recalculated for an intensity that is realistic for local conditions.

The slope of the gutter will be limited by the vertical gap between the eaves and the gutter at the lower end of the run. If this gap is much greater than the diameter of the channel small discharges will be blown clear of the gutter by quite moderate winds. A slope of 1% (0.125 inch per 1 foot run) may be taken as an average, in which case an eaves length of 10 metres will result in a vertical gap of 10 centimetres. Lengths well over this will require two or more vertical downspouts with consequent increase in cost. In Table 16.1 the roof areas that can be drained by gutters installed with slopes of 0.5%, 1% and 2% are shown for purposes of comparison. This table can be adjusted to allow for other slopes permitted under the code and can also be extended as needed to cover gutters of larger diameters.

TABLE 16.1 GUTTER SLOPES AND ROOF DRAINAGE: RAINFALL INTENSITY 100 mm PER HOUR

Guttering diameter		Roof area drained with gutter slopes of:					
		0.5% (1 in 200)		1% (1 in 100)		2% (1 in 50)	
mm	inches	m ²	ft ²	m ²	ft ²	m ²	ft ²
80	3	16	170	22	240	32	350
100	4	33	360	47	510	67	720
125	5	58	625	82	880	116	1 250
150	6	89	960	126	1 360	178	1 920

Source: Taylor & Wood 1982 (p. 156).

The area of roof to be drained is calculated on the basis of the horizontal projection and not on the actual surface of a sloping roof. Table 16.2 shows the maximum roof area that can be drained by five common sizes of vertical downspouts or leaders when the rainfall intensity is 100 millimetres (4 inches) per hour. These are suitable either to take the discharge from guttering or from flat roofs drained directly into these leaders. The figures should be adjusted to apply to discharges from storms of different intensity according to local conditions and experience.

TABLE 16.2 ROOF AREAS DRAINED BY VERTICAL DOWNSPOUTS: RAINFALL INTENSITY 100 mm PER HOUR

Diameter of downspouts		Roof area drained	
mm	inches	m ²	ft ²
50	2	65	700
65	2.5	120	1 300
80	3	205	2 200
100	4	430	4 600
150	6	1 255	13 500

Source: Taylor & Wood 1982 (p. 157).

Table 16.3 shows the total roof area, the discharge from which may be conveyed by horizontal drains (above or below ground) into which one or more vertical downspouts are connected, and which may also serve to drain paved areas such as courtyards. The same storm intensity has been assumed and three gradients – 1%, 2% and 4% – have been tabulated. Again, amendments and extrapolations should be made to suit local conditions or any requirements of the local code.

TABLE 16.3 CAPACITIES OF HORIZONTAL STORM DRAINS: RAINFALL INTENSITY 100 mm PER HOUR

Diameter of drains		Area to be drained with a slope of:					
		1% (1 in 100)		2% (1 in 50)		4% (1 in 25)	
mm	inches	m ²	ft ²	m ²	ft ²	m ²	ft ²
80	3	75	820	110	1 180	150	1 620
100	4	175	1 880	245	2 640	350	3 770
150	6	495	5 350	700	7 550	995	10 700
200	8	1 070	11 500	1 515	16 300	2 135	23 000

Source: Taylor & Wood 1982 (p. 157).

17. Intermediate and communal models for drinking-water supply and sanitation

Plumbing codes usually require that every occupied building should have a supply of drinking-water. A piped drinking-water system will require a sewerage system to dispose of the increased volume of wastewater that is generated. Until these are achieved, “plumbing”, in the sense used in these guidelines, is impossible. There are various intermediate stages between the use of an unprotected natural source and the attainment of this goal. This includes situations where public drinking-water supply and waste disposal are only partly available, and where cost or other constraints require the establishment of basic communal sanitation facilities as an interim measure.

17.1 Intermediate types of drinking-water supply and sanitation

In a community with no public drinking-water supply service, the first improvement that may be made is the provision of a safe water source such as a protected well or protected spring. The second may be the provision of a handpump or other device through which water can be delivered directly into a carrying container. The next stage may be the establishment of a central point to which water is pumped, and where it is stored and possibly chlorinated before being collected. A further improvement comes when treated water is piped to public standpipes close to the homes of those who will draw their water from them, or the piping of water to a private standpipe within each property or compound. The final stage before the installation of plumbing and plumbing fixtures is the installation of a single faucet within the house, usually serving a kitchen sink.

The foregoing service level is linked to likely quantities of water used and the hygiene consequences of such use. Table 17.1 illustrates a ladder of services under the perspective of distance and time to source.

From a public health point of view, the crucial aspects to take into account include the protection of the water source to prevent contamination, and provision of access to water on individual properties, thus eliminating the need for carrying household supplies and storing them within the home. In many cases the earlier stages may be bypassed, such as when a complete new public drinking-water supply is installed in a community that previously had no protected water source. More commonly, economic constraints make it necessary to provide a somewhat more restricted service initially so that the drinking-water supply is improved incrementally in parallel with the community’s improving social conditions.

TABLE 17.1 SERVICE LEVEL DESCRIPTORS OF WATER IN RELATION TO HYGIENE

Service level description	Distance/time measure	Likely quantities collected	Level of health concern
No access	More than 1000 metres, or 30 minutes total collection time	Very low: often less than 5 litres per capita per day	Very high as hygiene not assured and consumption needs may be at risk. Quality difficult to assure; emphasis on effective use and water handling hygiene
Basic access	Between 100 and 1000 metres, or 5 to 30 minutes total collection time	Low: average is unlikely to exceed 20 litres per capita per day; laundry and/or bathing may occur at water source with additional volumes of water	Medium: not all requirements may be met. Quality difficult to assure
Intermediate access	On plot, e.g. single tap in house or yard	Medium: likely to be around 50 litres per capita per day, higher volumes unlikely as energy/time requirements still significant	Low: most basic hygiene and consumption needs met. Bathing and laundry possible on site, which may increase frequency of laundering. Issues of effective use still important. Quality more readily assured
Optimal access	Water is piped into the home through multiple taps	Varies significantly but probably above 100 litres per capita per day and may be up to 300 litres per capita per day	Very low: all uses can be met, quality readily assured

Source: Howard and Bartram 2003.

It is important to emphasize the ultimate goal of providing on-plot water supplies to every household, and to ensure that providing any intermediate level of service is carried out with this ultimate goal in mind. For instance, mains laid to public standpipes should not be of a size merely adequate to serve those standpipes, but of sufficient carrying capacity to permit house connections to be made later. Otherwise, the expense of replacement by larger diameter pipes in the future will be an obstacle to the implementation of the next stage of improvement.

Where mains and sewers are planned to be installed in the near future, or where water supplies but no sewers have been constructed, any private intermediate arrangements should be so designed and installed as to be readily adapted to comply with local codes of practice. This will ultimately be advantageous to both the individual householder and to the authority having jurisdiction. Connection to a future public supply is made easier and cheaper if the internal piping and fixtures already comply with the relevant provisions of the plumbing code. Similarly, drainage to a septic tank or cesspool should be so

designed and installed that it can be diverted to a future sewer from a convenient access chamber with no alteration necessary other than the disconnection and filling in of the disposal tank or cesspool.

17.2 Household water treatment

In the absence of access to a safe and reliable central water system, consumers must make their own provisions to be assured of the safety of the water that they use for drinking and food preparation. Several methods are available and more are in development. They range from low-tech approaches like boiling to chemical disinfection using chlorine or iodine, various forms of sand or ceramic filters and disinfection using sunlight. More sophisticated techniques include combined coagulation and disinfection products, ultraviolet lamps and devices that can disinfect, filter and remove chemicals and improve the aesthetic quality of the water, and more expensive solutions like safe bottled water. Disinfection is almost always essential. Water authorities should initiate these programmes and work to ensure that a range of these technologies or systems are available, such that consumers can choose what is acceptable, affordable and appropriate for their household. As a minimum they should work to ensure that the training and information that consumers need to make good decisions is available. Authorities should also monitor these situations to be sure that the household treatment is functioning successfully. It is always important that the water quality problem is understood so that appropriate treatment methods can be selected if something beyond microbial control is a concern. It is also important that, where appropriate, water treatment devices have been tested and certified to specific claims and performance (Cotruvo 2005; WHO 2005). With recent research indicating that household-based approaches to managing water are cost effective, lead to significant diarrhoeal disease reductions and are rapidly deployable, WHO has taken the lead in coordinating the International Network to Promote Household Water Treatment and Safe Storage (WHO 2006b).

17.3 Communal systems for drinking-water supply and sanitation

Factors other than installation costs may delay improvements at an intermediate stage. In densely populated or periurban slum areas, the cost of internal plumbing might be greater than the value of the properties to be served. It might seem logical in this case to halt drinking-water supply improvements at the public standpipe stage pending the renovation and rebuilding of unsanitary housing. However, waterborne infectious disease will not wait and it is those in vulnerable circumstances that are most in need of facilities for safe drinking-water, personal hygiene and clothes washing. In the interim, provision of communal latrines, bathhouses and laundries may therefore be a reasonable strategy, their expense being justified by the improvement in the health of the public as a whole, as well as in the quality of life of the individuals who will use them.

A form of sanitation particularly suitable to crowded cities is the aqua privy, consisting of a single underground septic tank upon which are built a number of individual latrines. Outlets from the latrines drop vertically through the tank roof and discharge under the surface of the septic liquid below. If properly designed, constructed and maintained, an aqua privy can serve the needs of four or more households, each having its own private cubicle containing a latrine. Sewage is broken down and liquefied and the effluent liquid is comparatively innocuous. However, under dense population conditions the removal of this liquid may present a problem if the subsoil is impervious. A drainage system to collect the effluent from a number of aqua privies may be constructed at a fraction of the cost of sewers. Because only liquid is discharged and there is consequently no danger of blockage, smaller pipe sizes may be used for the drains. Accumulated solids either must be removed when the system is filled to capacity or another site found, and the excavation suitably covered and backfilled.

Plumbing in and for communal facilities needs to be more robust than that installed on private premises. Precautions need to be taken in the design against vandalism, theft and misuse. Brass faucets are particularly subject to vandalism if they can be easily unscrewed: drilling a hole in the threaded union and fastening with a set screw or rivet is one security method. Standpipes and exposed piping may be embedded in concrete, though this makes maintenance more difficult. High-level flushing cisterns and shower control valves may be mounted above the ceiling with only the chain and handle visible in the cubicle. The seats of pedestal water closet bowls can be made of sturdy wood, preferably open at the front and fixed, rather than of hinged plastic. Control valves, whether below ground or mounted in the building, are better enclosed in lockable boxes. Similar considerations may govern the design of truly public facilities, like those erected in markets or other public places.

The plumbing of multiple latrines, bathhouses and laundries should comply with the general principles of the plumbing code with regard to cross-connection, backsiphonage and backflow. By providing each with its own storage tank, peak use flows are evened out and economies may be possible in the delivery mains and connections. In many arid areas, it is customary to provide storage at groups of standpipes for the same reason.

Above all, the maintenance of the installations will depend upon the cooperation of those using them. Efforts to build a sense of communal ownership and pride of possession are important so that cooperation is voluntarily given or assured by peer pressure, and enforcement is therefore unnecessary. In this way, communal sanitary facilities can be kept clean and working with the minimum need for supervision and inspection.

18. Conservation of water in public and domestic supply systems

All water, even wastewater, has value and it should not be wasted. The conservation of clean water depends on minimizing wastage from leaks and reducing unnecessary or excessive consumption. Some wastage appears to be inevitable in every drinking-water supply system, and the term “waste prevention” is used here for measures intended to reduce losses to a minimum. In this context, the term “waste” refers to water that escapes from the system unused or unaccounted for, and not to human wastes or other forms of used or degraded water that are carried away by drains or sewers. There are cases where in the order of 60% of the distributed water is unaccounted for, and not billed, due to leaks or non-metering.

Wastage and leakage of water can occur from the public (mains) system or in the private systems owned by individual customers. In the public supply system, the best protection against wastage is the careful design and construction of the mains, combined with an active programme of supervision and preventive maintenance and leak detection. In the private system, the main strategies are the prompt correction of leaks, the use of technologies to reduce overuse, and public education on water conservation, as well as metering and use of rate structures that are a function of volume consumed versus block billing.

While leaks in the public mains system can be minimized by systematic inspection and maintenance by the authority concerned, it is more difficult to trace and remedy leaks on private property. A relatively small (3 millimetres) leak in a service pipe, or a dripping tap, under normal working pressure can waste 340 litres (90 US gallons, 75 UK gallons) per day, the amount required to supply the needs of a family of three. While leaks within private properties are charged to the property owner, a multiplicity of leaks can compromise the drinking-water supply system. Leakage and wastage on private property can be minimized by the use of quality materials and workmanship in the installation of plumbing systems, as well as promptly instituting repairs when needed.

Leakage into drains (infiltration) can lead to the overloading of sewers and sewage disposal works, with consequent additional expense to the sewerage authority. The infiltration of storm water into wastewater disposal systems may create health hazards. Measures must be taken to exclude materials that can choke sewers, or those of inflammable, explosive, corrosive or toxic nature that may be potentially dangerous to the public, or may interfere with the purification process at the disposal works.

Leaking pipes significantly increase the vulnerability of pipelines to contamination, especially where the supply is intermittent or the pressure fluctuation can lead to infiltration of contaminated water into the distribution system.

18.1 Special problems associated with public buildings and communal accommodation

Public health authorities have a particular interest in the plumbing of buildings used by large numbers of people, such as schools, lodging houses, hotels, public baths, hospitals and transport terminals. Unsafe or inadequate water and waste system plumbing in those establishments can lead to major outbreaks of infectious disease. For this reason, sanitary fittings must be appropriate for the high level of use and must be installed and maintained so as to minimize risks to health. Special precautions are necessary on premises where food and drink are processed, stored or served to the public.

The responsibility for ensuring that public plumbing systems conform to effective hygienic standards is primarily located with the drinking-water supply authority and the body responsible for sewage disposal. The health authority has the overall task of ensuring that these water and sewerage authorities take their responsibilities seriously. The day-to-day supervision of new plumbing installations is often the responsibility of a local agency, the building control inspector, whose prime duty is to ensure the stability of the particular premises in which the plumbing system is installed, and the safety of its occupants. Supervision of plumbing installations requires special knowledge and skill, so it is essential that well-trained and conscientious plumbing inspectors are serving in those critical functions.

18.2 Leakage and wastage in the public drinking-water supply system

No public supply is completely leakproof; not even the best-designed and carefully constructed system can remain absolutely watertight throughout its life. An efficient public drinking-water supply authority will therefore maintain a continuous programme of inspection and preventive maintenance to discover and stop leakage for both financial and health reasons. Unaccounted-for water represents a lost opportunity for the authority to earn income from the supply of water. Leaks that allow water to flow out of the system can also provide the means of entry for contaminants, which may in turn cause illness. A further reason to maintain a continuous programme of inspection and timely implementation of repairs to the public drinking-water supply mains is that it sets an example for the owners of private properties to maintain their own drinking-water supply systems so as to minimize waste.

Wastage below ground is difficult to detect and isolate and often expensive to remedy. The best strategy is therefore to ensure that the drinking-water supply systems are built to the highest possible standards. The selection of materials,

installation practices and workmanship in both public and private drinking-water supply systems should all contribute to reducing the incidence of unseen wastage. The usual procedure for tracing these leaks in the mains system is a combination of district metering and inspection of the mains and services with a leak detection system such as a listening device between midnight and dawn when supply demands are low. This can be followed by the investigation of suspect properties.

18.3 Leakage and wastage from private drinking-water supply systems

Leakage from piping systems within a building is usually self-evident because it threatens to damage the building structure and internal walls and fittings. It is in the interest of the owner of the property to have this remedied promptly, especially since a leak can become progressively worse as the escaping water increases the size of the orifice through which it emerges. In certain situations, especially where water charges are not based on metered volumes of water used, powers of enforcement may have to be used to compel those responsible to undertake repairs.

Another type of wastage is very difficult to control without the cooperation of the building's occupants, namely that due to leaking taps, valves or incorrectly adjusted fittings in fixtures such as washbasins or toilet cisterns. Because the wastewater is conveyed through the fixture to the drainage system or is discharged through an overflow, it may cause no obvious nuisance within the building, and therefore there is less incentive for the property owner to take action to fix the leak. In large buildings, factories or high-density housing estates, the total wastage due to this cause may be very considerable. The actual cost of replacing worn washers and adjusting leaking fittings is minor once the leaks have been identified. Because of this, some drinking-water supply authorities offer to carry out simple remedial works or repairs free of charge to consumers, thus encouraging them to report such faults at an early stage.

18.4 Use of meters to reduce wastage and excess consumption

Installation of individual water use meters in all properties is an important strategy to encourage consumers to repair leaks promptly and to avoid excessive use of water. Metering ensures that the cost of wasted water will be borne by the individual consumer rather than by the public authority. This strategy is effective in the case of large commercial and industrial premises and in large multiple dwellings where there are facilities for inspection and repair by maintenance staff. This strategy should also be applied to single dwellings, which usually constitute the greatest part of the total demand for a drinking-water supply in non-industrialized communities.

Meters are an essential tool in the proper management of a water distribution system. In many countries there is a trend towards private operation of water

supplies or the corporatization of publicly owned water suppliers, which in turn leads to full-cost accounting. Assistance to disadvantaged persons can then be provided from the public purse rather than a system of implicit subsidy by higher water users, such as hospitals, schools, sports grounds or industries.

The provision and installation of meters does not represent the final cost of their use. Meters have a limited life and are a continuously depreciating investment. Facilities for repair and calibration must be provided and a team of meter readers and supporting clerical personnel must be supported, although remote sensing systems have been developed that obviate the need for direct reading. In some cases the cost of installation of meters in all domestic premises in a supply area may be greater than the cost of supplying consumers with more water to compensate for the wastage than might have been prevented by metering. However, the latter presupposes that not only is there unlimited low-cost source water and the means to treat it, but also that there is adequate capacity for sewage treatment of waste flows if the wastage is going to drains. It also assumes that there is no risk of contamination if the leakage is from pipes. Many analysts conclude that the compensation for increased demand due to wastage by increasing supply is at best a short-term fix. In addition, reducing wastage with meter use may allow consumer demand to be met from the existing supply for a longer time, therefore reducing the overall cost of water.

If every connection to the main supply has its own meter, the meters can help reduce the cost of supplying water by assisting with the identification of unaccounted-for water, below ground leakage and excess usage. Underground leakage through the mains and branches can be detected by comparing the quantity of water entering a district or section of the mains system (through a recording meter inserted in the mains) with the sum of the quantities registered on the individual meters on outlets connected from that section of the mains during the same period. Similarly, when individual meter readings are higher than average, the property owner will become alerted and will be more likely to identify the cause and take corrective action.

18.5 Minimizing systematic excessive and wasteful use of water

In a new drinking-water supply area, the entire distribution system may be designed with the efficient use of the available water in mind, water pressures may be regulated and maximum flows and capacities of plumbing fixtures regulated by the plumbing code. In older systems there are a number of actions that can be taken, but the first and most important is to secure the cooperation of consumers through publicity, education and other forms of communication.

In some instances it could be economical to fund the retrofit of water-saving fixtures and flow controls in private connections so as to lower demand. These costs may be less than the expenditure on infrastructure to increase supply. Larger consumers may be persuaded to install devices to cut down water use if

free audits are provided to quantify and cost the potential savings. Use of flow control valves and efficient shower heads should be encouraged, and consumers should be made aware of the substantial additional savings in heating costs for hot water that can be achieved. In establishments such as large factories, industrial complexes, mining camps and hotels, where large numbers of people use showers and handwashing facilities, the savings on energy by reducing the demand on hot water generation will dramatically reduce the payback period for expenditures on flow control valves and efficient shower heads.

In domestic properties with flushing toilets the toilet may account for one third of the daily household consumption of water. Low flush toilets that utilize 5 or 6 litres (1.5 US gallons) versus about 20 litres (5 US gallons) per flush are now widely available. Washing, bathing and showering may account for an additional one third of water used within the home. By regulating toilet flushing volumes and the flow rates at washbasin taps and showers heads it is possible to conserve up to half of this water without loss of amenity to the householder.

Care is needed when regulating the flow rate of hot water taps and showers as some of the instantaneous types of water heaters are flow regulated at the unit and further flow reduction at the tap may be detrimental to the operation of the hot water heater. Shower heads also require careful consideration, as fitting a flow restrictor to a poorly designed shower head may reduce the amenity to the user to such an extent as to cause the consumer to remove the restrictor and return to higher flow rates. In multiple shower installations the risk of thermal shock or temperature spiking must be taken into account. These problems can often be traced to poorly balanced flow rates at various taps or shower heads.

A guide to the water use efficiency of showers, as determined by flow rates at the point of use under normal drinking-water supply conditions and pressures, is as follows:

- 6–8 litres per minute: Very good
- 8–12 litres per minute: Good
- 12–18 litres per minute: Reasonable
- 18–24 litres per minute: Fair
- > 24 litres per minute: Poor and very wasteful

18.6 Minimizing water usage in flushing cisterns

There are three main categories of flushing cisterns that are connected to toilet bowls – high level, intermediate level and close coupled. The application of the high-level cistern is normally restricted to a single flush operation, whereas the intermediate and close-coupled toilet cisterns are available in a variety of designs and materials incorporating a dual flush function. Typically, the full flush volume is 6 litres (1.6 US gallons or 1.4 UK gallons) and a half flush volume is 3 litres (0.75 US gallons or 0.66 UK gallons) or less. Plumbing codes must ensure that

only matching toilet bowls designed to operate with low flush volumes are used in conjunction with these dual flush or low flush cisterns. The volume of the larger flush in a dual flush system should not exceed 6 litres, and the lesser flush volume must not exceed two thirds of the larger flush volume. Urinals with flushing controls are also available. Sensors control their operation so that flushing does not occur when they are not in use. Waterless urinals are also available that can achieve significant savings if they are installed and maintained correctly.

Reduced toilet flushing volumes may cause problems if the drainage system does not have a substantial flow into the system upstream of the toilet. When water flows are too low, solids may be stranded in the drainage piping and may cause blockages. This and similar problems can be avoided if plumbing codes are regularly revised to incorporate new design practices.

Although the half flush is an important strategy for reducing water usage in cisterns, it may not be effective when toilet tissue paper is used with a half flush. The problem is that the tissue paper often becomes stranded at the outlet weir of the toilet bowl. This in turn results in the draining out of the water trap seal due to the inability of the reduced flush volume to carry the tissue paper clear of the water seal zone of the bowl. After one or two such events the user may resort to using the full flush every time and the potential benefits of the dual flush system are lost.

In areas of extreme water scarcity it may be necessary to install chemical or composting toilets instead of water closets. There are a number of types, but most are self-contained. Since they do not strictly come under the heading of plumbing fixtures, they will not be discussed here.

18.7 Minimizing water wastage in lawn and garden irrigation

When promoting a water use efficiency programme, steps should be taken to minimize the use of drinking-water on gardens and lawns. More than 40% of household water use can be external in households in dry areas that have fully established gardens and lawns. Advice on appropriate gardening practices, selection of plants suitable for the local climate and suitable irrigation watering schedules all help to reduce water use without loss of amenity. In localities with high daytime temperatures, lawn and garden watering and some other external high-volume uses should be banned during the hottest part of the day to reduce loss through evaporation. In some situations, more drastic restrictions or bans on lawn watering and other high-volume external uses may be required, at least seasonally.

18.8 Attempts to reduce water usage through intermittent supply

Water authorities adopt various expedients to reduce consumption by the public during periods of water shortage. One of the most unacceptable is to make

supplies intermittent. In this strategy mains supply to all or part of the system is shut down completely during certain hours of the day. One of the worst consequences is the development of negative pressures, which carries a risk of serious backflow contamination of mains water. In addition, deposits of rust, detritus and other sediments within the mains are stirred up and carried in suspension when the flow resumes. Air may be drawn into the system, causing airlocks or water hammer. Cessation of mains flow means that emergency calls for water for firefighting cannot be met without undue delay.

It is also doubtful whether significant savings result in the long run, since consumers fill bathtubs and containers in anticipation of shutdowns. During the shutdown period, consumers may turn on a water tap and, finding that the supply is unavailable, leave the tap in the open position; water is then wasted when supply is resumed. Although water is not available during the shutdown period, after the supply is returned to normal there may be considerable water wastage through open taps and the disposal of excess water that was stored in baths or sinks. These losses could easily cancel out any potential water savings.

A better strategy is to maintain adequate pressure in the distribution mains to eliminate low or negative pressures in hilly conditions or where tall buildings must be served. The flow to individual premises can be controlled by inserting pressure reduction or limiting valves adjacent to the water authority's stop valves for each service. Thus, the system can more easily be balanced to provide each branch with adequate flows at all times. Further balancing of flows and pressure is then possible in each private service feeding multiple dwellings or tall buildings so as to provide equal amenity to all consumers. It is important that all branches from the main distribution system are regulated, as any uncontrolled flows will have an adverse effect on a balanced system.

The plumbing of multiple latrines, bathhouses and laundries should comply with the general principles of the plumbing code with regard to cross-connection, backsiphonage and backflow. By providing each with its own storage tank, peak use flows are evened out and economies may be possible in the delivery mains and connections. In many arid areas, it is customary to provide storage at groups of standpipes for the same reason.

Above all, the maintenance of the installations will depend upon the cooperation of those using them. Efforts to build a sense of communal ownership and pride of possession are important so that cooperation is voluntarily given or assured by peer pressure, and enforcement is therefore unnecessary. In this way, communal sanitary facilities can be kept clean and working with the minimum need for supervision and inspection.

19. Wastewater use

The use of wastewater for a variety of purposes is gaining increased popularity as a means of preserving scarce freshwater resources. Wastewater and greywater use is increasingly considered a method combining water and nutrient recycling, increased household food security and improved nutrition for poor households. Economic and environmental pressures, and the conservation ethic, have led to widespread and growing applications for recycling of wastewater, including irrigation of food and non-food crops, green spaces, recovering arid land, fire systems, industrial cooling or industrial processing, sanitation and even as indirect and possibly direct sources of drinking-water. The beneficial use of wastewater also helps to decrease the impact on the environment of disposal of sewage or industrial effluent. The end use of wastewater determines the required quality of the water and management procedures required to ensure safety. WHO and several countries have developed guidelines and standards for the safe use of wastewater in agriculture and other settings (WHO 2006a).

19.1 Use of greywater

There has been considerable focus on the use of greywater. The *2000 Uniform Plumbing Code illustrated training manual* published by the International Association of Plumbing and Mechanical Officials defines greywater as “untreated household wastewater which has not come into contact with toilet waste. Greywater includes used water from bathtubs, showers, bathroom wash basins, and water from clothes washing machines and laundry tubs. It shall not include wastewater from kitchen sinks or dishwashers” (IAPMO 2000). Even though greywater does not include wastewater, pathogens may still be present from different sources (e.g. babies’ nappies or diapers). However, pathogen concentrations are generally much lower than in wastewater. Greywater can be used in domestic installations, for water closet flushing and for garden watering. Depending on the use, greywater may require some treatment (e.g. disinfection) or management steps prior to application to ensure safety. For example, greywater used for garden irrigation should not be distributed by aerial spraying, as there is high risk of spreading airborne infectious particles (see section 14.5). But if the greywater is applied below the soil surface for landscape irrigation, little or no treatment may be necessary. WHO has recently completed Guidelines for the Safe Use of Wastewater, Excreta and Greywater, which provide more

information on risk management associated with the use of these substances (WHO 2006a). Table 19.1 summarizes the suitability of different grades of water for use in different applications.

TABLE 19.1 SUITABILITY FOR USE OF DIFFERENT GRADES OF WATER

Water grade	Definition and reuse applications
Greywater	Water from a potable source that has already been used for bathing, washing, laundry or washing dishes
Wastewater	Combined domestic effluent that contains sewage
Reclaimed water	Water that has been treated so that its quality is suitable for particular specified purposes, e.g. irrigation, toilet flushing, etc.
Green water	Reclaimed water that has been treated to a relatively high standard, suitable for general use as a non-potable source in parallel with the potable source. It may be identified through inclusion of a green dye and supplied through a dedicated pipework system
Drinking-water	Very high-quality water assured to be suitable for drinking by humans

19.2 Use of wastewater

Greywater does not include the wastewater from toilets, urinals or bidets. The discharges from these fixtures are classified as wastewater (sometimes referred to as black water), because they contain high levels of pathogenic organisms and solids. Such discharges should undergo specialized treatment prior to any secondary use. The installation and operation of wastewater use systems must be strictly controlled. Safe wastewater use systems require subsoil discharge in order to limit the amount of exposure to humans and animals, so minimizing any possibility of transmission of infections by viruses, bacteria or parasites. However, precautions should be taken to avoid the contamination of ground-water resources used for drinking-water.

In larger urban sewerage systems, the effluent from at least secondary treated community sewage treatment plants can be reclaimed by filtration, disinfection and other more advanced treatments (e.g. membranes) and sold for industrial processes or cooling, or used for irrigation of community sports grounds and gardens, or even for indirect potable reuse. Industrial and mine processing sites may set up internal recycling of cooling and process water to reduce their reliance on community supplies. A comprehensive overview of management measures for the reuse of wastewater in agriculture and aquaculture is presented in the WHO guidelines (WHO 2006a).

19.3 Management of dual water systems

Community and large industrial water reuse systems require a separate water distribution system that runs parallel to the drinking-water distribution system. Extreme care is required to keep the two systems separate, to prevent cross-

connection and to prevent inadvertent use of non-potable water for food preparation or consumption by both humans and animals. Dual water systems of this type must be clearly identified with a system of colour coding, labels and tags that conform to a national standard. All non-potable water outlets must be clearly labelled, and should be physically separated from potable (drinking) water outlets. Where possible, non-potable water outlets should be locked off to prevent unauthorized use. In a domestic environment non-potable water is best restricted to uses such as water closet flushing or garden irrigation. A closed distribution system will prevent casual use of the water for other uses.

Another potential user of a dual water system is the firefighting service. However, water outlets such as hydrants used for firefighting may also be illegally used by the public for domestic purposes. Epidemics have been traced to the use of water from fire hydrants for domestic purposes in the poorer sections of cities where the fire service water is drawn from water supplies of unknown quality. Because unauthorized use cannot be prevented, fire hydrants in public places should be supplied with safe drinking-water when possible.

19.4 Identification of potable and non potable-drinking-water systems

The pipes in all buildings having drinking-water and non-drinking-water systems must be clearly identified. The following is a suggested system of colour codes and labels used to identify different grades of water:

- Drinking-water: green background with white lettering
- Non-drinking-water: yellow background with black lettering, with the words “Caution – non-potable water, do not drink” or “Non-drinking-water, do not drink”.
- Reclaimed water: purple or lilac (Pantone colour #512) background, imprinted in nominal 12.7 millimetre (0.5 inch) high, black, upper case letters with the words “Caution – reclaimed water, do not drink”.
- Each system shall be identified with a coloured band to designate the liquid being conveyed, and the direction of normal flow shall be clearly shown. The minimum size of the letters and length of the colour field shall conform to the recommendations in Table 19.2.
- A coloured identification band shall be indicated every 6 metres (20 feet) but at least once per room, and shall be visible from the floor level. Where vacuum breakers or presenters are installed with fixtures, identification of the discharge side may be omitted.
- Each outlet on the non-potable water line that could be used for special purposes shall be posted as follows: “Caution – non-potable water, do not drink”.

TABLE 19.2 MINIMUM LENGTH OF COLOUR FIELD AND SIZE OF LETTERS

Outside diameter of pipe or covering in inches (mm)	Minimum length of colour field in inches (mm)	Minimum size of letters in inches (mm)
0.5–1.25 (13–32)	8 (203)	0.5 (12.7)
1.5–2.0 (40–50)	8 (203)	0.75 (19.1)
2.5–6.0 (65–150)	12 (305)	1.25 (32.0)
8–10 (200–250)	24 (619)	2.25 (64.0)
> 10 (> 250)	32 (813)	3.5 (89.0)

Source: IAPMO 2003.

Additional information on grey water systems, reclaimed water systems, private sewage disposal systems, and drinking-water supply and distribution systems can be obtained from the following organizations:

World Plumbing Council (WPC)

KPMG Fides

14 Chemin De-Normandie

CH-1206

Geneva, Switzerland

www.worldplumbing.org

International Association of Plumbing and Mechanical Officials (IAPMO)

5001 East Philadelphia Street

Ontario, CA 91761-2816 USA

www.iapmo.org

Institute of Plumbing & Heating Engineering (IPHE)

64 Station Lane

Hornchurch, Essex

RM12 6NB

United Kingdom

<http://www.iphe.org.uk/>

World Health Organization

Water, Sanitation and Health Programme

20 Avenue Appia

1211 Genève 27

Switzerland

http://www.who.int/water_sanitation_health/en/

Glossary of plumbing and other terms used in the text

- access chamber.** An opening into the ground from which drains can be inspected and rodded or cleaned out, both towards and away from a building, also acting as a junction into which the drainage from other plumbing fixtures may discharge into the horizontal drain.
- accessible.** In reference to a plumbing fixture, appliance, equipment or connection: easily reached, though the use of tools may be required to remove an access panel or open a door.
- air break.** A physical separation between any pipe and receptor through the free atmosphere. The separation may be below the flood level of the receptor but above the trap seal.
- air gap.** A physical separation between a safe drinking-water system and above the flood level of the receptor. The separation should be at least twice the supply pipe diameter, but never less than 25 millimetres (1 inch).
- authority.** An individual official, board, ministry or other political entity established and authorized by governmental sanction or a specific law enacted by a governing body that confers statutory powers to formulate and enforce a code of practice for plumbing.
- backflow.** The reversing of the normal flow of water or other substances into the drinking-water distribution system from any unintended source.
- backpressure.** The reversing of normal flow resulting from a pressure downstream that is higher than the supply pressure in the distribution piping of a drinking-water supply system.
- backsiphonage.** The reversing of normal flow resulting from negative or subatmospheric pressures in the distribution piping of a drinking-water supply system.
- backwater valve.** A device for preventing sewage or drainage water from flowing back into a building in the event of flooding or sewer blockage.
- black water.** Combined domestic effluent including liquid and solid human body waste and the water discharged from toilet usage.
- building drain.** The lowest part of a building drainage system where the drainage pipes meet and convey the discharge from within the walls or footings of any building to the building sewer. Also called *house drain*. See also **combined building drain; sanitary building drain**.
- building sewer.** That part of the horizontal piping of a drainage system that extends from the end of the building drain and that receives the discharge of the

- building drain and conveys it to a public sewer, private sewer, private sewage disposal system or other point of disposal. Also called *house sewer*. See also **combined building sewer; sanitary building sewer; storm building sewer**.
- building subdrain.** That portion of a drainage system that does not drain by gravity into the building sewer. Also called *house subdrain*.
- check valve.** A valve that allows the flow of a liquid in only one direction but closes when the normal direction of flow is reversed.
- cistern.** A vessel open at the top to the atmosphere used to hold a supply of cold drinking-water.
- cleaning eye.** *Same as* access chamber.
- colour marking.** The marking of pipes and fittings with different colours to designate the application of the product and to assist installers in identification and prevention of cross-connections.
- combined building drain.** A building drain that conveys both sewage and storm water or other drainage.
- combined building sewer.** A building sewer that conveys both sewage and storm water or other drainage.
- conservation.** The preservation and protection of natural resources.
- corrosion.** A surface reaction causing a gradual erosion of the material affected.
- cross-connection.** Any physical connection or arrangement between two otherwise separate piping systems or containment means, one of which contains potable water, and the other water or fluid of unknown or questionable safety.
- disinfection.** Killing or rendering harmless microbial contaminants by chemical or physical processes.
- downpipe or downspout.** A vertical drainage pipe for conveying storm water from the roof or gutter drains.
- drain.** Any pipe that carries waterborne waste in a building drainage system. See also **building drain; storm drain; subsoil drain**.
- drainage system.** All the piping within public or private premises that conveys sewage or other liquid wastes to a point of disposal. It does not include the mains of a public sewer system or a public sewage treatment or disposal plant.
- drain cock.** A valve, usually installed in the lowest portion of a piping system or vessel, that controls the flow of liquid from the system or vessel. Also called *drain valve*.
- dual system.** A situation in which a second plumbing system is installed alongside the system for provision of drinking-water. An example is a potable drinking-water system and a greywater system in the same facility.
- electrolysis.** A chemical change that occurs when an electric current is generated by the connection of two different metals, either directly or via an electrolyte solution.

fixture. *See plumbing fixture.*

fixture unit. An arbitrarily chosen scale or quantity that represents the load of a fixture on a drainage system. One fixture unit was originally established as 7.5 imperial (UK) gallons = 9 US gallons = 34 litres per minute discharge by gravity through a fixture.

flammable waste. Waste that is easily ignited and will burn.

float valve. A valve that operates by means of a bulb or ball floating on the surface of a liquid in a tank or container. The rise and fall action operates a lever, which opens and closes the valve.

flushometer valve. A device activated by direct water pressure to discharge a predetermined quantity of water to fixtures for flushing purposes.

frost protection. Methods, such as burial or insulation, used to protect against freezing of pipes or fixtures.

grease interceptor. A device, usually outside a building, that retains grease and prevents it passing into the sewerage system.

grease trap. A grease interceptor installed inside a facility, usually near the grease-producing fixtures.

green water. Reclaimed water that has been treated to a standard, suitable for general domestic non-potable applications. It may be identified through inclusion of a green dye and supplied through a dedicated colour-coded pipe-work system.

greywater. Water that has already been used for bathing, washing, laundry or dishwashing, but does not contain excreta.

indirect connections. Waste piping that discharges into a receptor or interceptor through an air break or air gap into the drainage system.

industrial waste. Liquid or waterborne waste from industrial or commercial processes.

inspection chamber. *Same as access chamber.*

interceptor. A device used to separate deleterious, hazardous or undesirable matter from normal wastes, retaining it while permitting normal sewage or liquid wastes to discharge into the drainage system by gravity.

liquid waste. The discharge from any fixture, appliance or appurtenance in connection with a plumbing system that does not receive faecal matter.

manhole. *Same as access chamber.*

mixing valve. A valve or faucet that mixes liquids using automatic or manual regulation.

negative pressure. Pressure below the external atmosphere pressure, taking into account the local elevation.

non-return valve. *Same as check valve.*

oil trap. An interceptor used to retain oil and prevent it passing into sewers.

overflow system. An outlet or receptacle designed to collect surplus liquids after the desired amount has been received.

- pH.** The negative logarithm (base 10) of the hydrogen concentration. On the scale of 0 to 14, 7 is neutral, lower numbers are acidic, and higher numbers are basic.
- plumbing fixture.** A general term applied to any plumbing receptacle, device or appliance that can be temporarily or permanently fixed in place. It is connected to the drinking-water supply or to the drainage system either by an indirect or direct connection.
- potable water.** *Same as drinking-water.*
- pressure reduction valve.** A device that regulates pressure in liquids or gases by reducing a higher pressure to a definite lower pressure, maintaining the liquids or gases at a constant pressure.
- pressure relief valve.** A safety valve that is held closed by a spring or other means and automatically relieves the pressure in excess of its setting. *See also temperature and pressure relief valve.*
- reclaimed water.** Water that has been treated so that its quality is suitable for particular specified purposes, such as irrigation, toilet flushing or possibly drinking. Also called *recycled water*.
- roof drainage.** Conveyance of rainwater from a sloping roof by gutters and downspouts, or from a vertical roof by pipe, to a surface water sewer or suitable soakaway.
- safe or potable drinking-water.** Water that is intended for human consumption and suitable for all usual domestic uses, complying with the requirements of the WHO Guidelines for Drinking-water Quality or appropriate national standards established by the regulating authority.
- sanitary building drain.** A building drain that conveys only domestic or industrial waste, not storm water.
- sanitary building sewer.** A building sewer that conveys only domestic or industrial waste, not storm water.
- sanitary sewer.** A sewer intended to receive only domestic or industrial waste, not storm water.
- sewage.** Liquid waste and wastewater generated by residential and commercial sources and carried in sewers.
- sewer.** A channel or conduit, usually subterranean, for carrying off water and waste matter, such as surface water from rainfall, household waste from sinks and baths, and wastewater from industrial works. *See also building sewer; sanitary sewer.*
- sewerage.** The works comprising a sewer system, pumping stations, treatment works and all other works necessary to the collection, treatment and disposal of sewage.
- sewer system.** System including a building sewer, a private or public sewer, and a private or public sewage disposal system.
- stop valve.** A key control valve capable of shutting off the whole plumbing system that is under mains pressure.

storm drain. The part of the horizontal piping and its branches that directs subsoil and surface drainage from areas, courts, roofs or yards to a building or storm sewer.

storm water drainage. Drainage of rainwater from roofs, courtyards and paved areas and conveying it away from buildings to a place of disposal.

subsoil drain. A drain that collects subsurface or seepage water and conveys it to a place of disposal.

temperature and pressure relief valve. A device that controls both temperature and pressure, releasing water to atmosphere at predetermined settings. *See also pressure relief valve.*

trap. A device or fitting that provides a liquid seal to prevent the emission of sewer gases without materially retarding the flow of sewage or wastewater through it.

vent. Any pipe provided to ventilate a plumbing system in order to prevent backpressure and trap siphonage, or to equalize the air pressure within the drainage system.

waste. *See liquid waste; industrial waste.*

wastewater. The spent or used water of a community, including from residences and commercial buildings, and any surface water or storm water that contains dissolved or suspended matter.

water closet. A water-flushing device or fixture designed to receive human waste directly from the user and discharge it to the drainage system.

Bibliography

- Ainsworth RG, ed. 2004. *Safe piped water: managing microbial quality in piped distribution systems*. WHO Drinking-Water Quality Series. London, IWA Publishing.
- Bartram J et al., eds. 2003. *Heterotrophic plate counts and drinking-water safety: the significance of HPCs for water quality and human health*. London, IWA Publishing.
- BRE (Building Research Establishment). 2001. *Vacuum drainage systems guidance*. United Kingdom, joint publication of BRE, Institute of Plumbing and Heating Engineering and Chartered Institution of Building Services.
- CDC (Centers for Disease Control and Prevention). 2003. *Guidelines for environmental infection control in health care facilities*. Morbidity and Mortality Weekly Report (MMWR) 2003/52(RR10):1–42. Available at www.cdc.gov/mmwr/preview/mmwrhtml/rr5210a1, accessed 21 January 2006.
- Cotruvo J. 2005. Point of use treatment for home and travel. In: Grabow W, ed. *Water and Public Health*, in *Encyclopedia of Life Support Systems (EOLSS)*. Oxford, UK, EOLSS Publishers.
- EPA (Environmental Protection Agency). 2003. *Cross-connection control manual*. EPA 816-R-03-002, February 2003. Available at www.epa.gov/safewater/crossconnection.html, accessed 21 January 2006.
- Exner M, Vacata V, Gebel J. 2003. Public health aspects of the role of HPC: an introduction. In: Bartram J et al., eds. *Heterotrophic plate counts and drinking-water safety: the significance of HPCs for water quality and human health* 12–19. London, IWA Publishing.
- Howard G, Bartram J. 2003. *Domestic water quantity, service level and health*. Geneva, World Health Organization.
- IAPMO (International Association of Plumbing and Mechanical Officials). 1997. *1997 Uniform Plumbing Code illustrated training manual*. Ontario, California, IAPMO.
- IAPMO (International Association of Plumbing and Mechanical Officials). 2000. *2000 Uniform Plumbing Code illustrated training manual*. Ontario, California, IAPMO.
- IAPMO (International Association of Plumbing and Mechanical Officials). 2003. *2003 Uniform Plumbing Code illustrated training manual*. Ontario, California, IAPMO.

- IPHE (Institute of Plumbing and Heating Engineering). 2004. *Disinfection*. Available at www.iphe.org.uk/databyte/disinfection.pdf, accessed 21 January 2006.
- IPHE (Institute of Plumbing and Heating Engineering). 2005. *Legionella*. Available at www.iphe.org.uk/databyte/legionella.pdf, accessed 21 January 2006.
- Stevens M et al. 2004. Risk management for distribution systems. In: Ainsworth R, ed. *Safe piped water: managing microbial water quality in piped distribution systems*. London, IWA Publishing.
- Surman-Lee et al. 2006 (in preparation). *Legionella and the prevention of legionellosis*. Geneva, World Health Organization.
- Taylor F, Wood W, eds. 1982. *Guidelines on health aspects of plumbing*. International Reference Centre for Community Water Supply and Sanitation (IRC) Technical Paper Series No. 19. The Hague, IRC.
- UNDP (United Nations Development Programme). 1999. *Human development report 1999*. New York, Oxford University Press.
- WHO (World Health Organization). 1998. *Three billion people worldwide lack sanitation facilities: WHO strategy on sanitation for high risk communities*. WHO press release, 29 January 1998. Available at www.who.int/inf-pr-1998/en/pr98-18.html, accessed 21 January 2006.
- WHO (World Health Organization). 2003. *Final report: Amoy Gardens*. WHO Environmental Investigation. Available at www.iapmo.org/common/pdf/ISS-Rome/SARS_Amoy_Gardens_HK.pdf, accessed 21 January 2006.
- WHO (World Health Organization). 2004a. *Guidelines for drinking-water quality*, 3rd ed. Geneva, WHO.
- WHO (World Health Organization). 2004b. *Water, sanitation and hygiene links to health*. Available at www.who.int/water_sanitation_health/publications/facts2004/, accessed 21 January 2006.
- WHO (World Health Organization). 2005. *Managing water in the home: accelerated health gains from improved water supply*. Available at www.who.int/water_sanitation_health/dwq, accessed 21 January 2006.
- WHO (World Health Organization). 2006a. *Guidelines for the safe use of wastewater, excreta and greywater* Volumes 1–4. Geneva, WHO.
- WHO (World Health Organization). 2006b. *The International Network to Promote Household Water Treatment and Safe Storage*. Available at www.who.int/household_water, accessed 9 February 2006.
- WHO/UNICEF (World Health Organization and United Nations Children's Fund). 2005. *Water for life: making it happen*. WHO/UNICEF Joint Monitoring Programme for Water Supply & Sanitation. Available at www.wssinfo.org/en/40_wfl_2005.html (p.13), accessed 21 January 2006.

Contributing authors

Neil Bogatz and Gabriella Davis, Project Co-Administration, International Association of Plumbing and Mechanical Officials, USA
Robert Burgon, Scottish and Northern Ireland Plumbing Employers Federation, Scotland
Sid Cavanaugh, United Association of Journeymen and Apprentices of the Plumbing and Pipe Fitting Industry of the United States and Canada
Joseph Cotruvo, Joseph Cotruvo & Associates, LLC, USA
Dale Courtman, Institute of Plumbing and Heating Engineering, United Kingdom
John Halliwill, International Association of Plumbing & Mechanical Officials, USA
Don Keenan, Master Plumbers, Gasfitters and Drainlayers New Zealand, Inc., New Zealand
Ralph T. Martin, The Institute of Plumbing, Australia
Stephen J. Movley, The Institute of Plumbing, Australia
Frank Penfold, Ontario Plumbing Inspectors Association, Canada
Plumbing Industry Commission Authority of Victorian Government, Australia
Plumbing-Heating-Cooling Contractors National Association, USA
Hari Ramanathan, International Association of Plumbing and Mechanical Officials, USA
Edward Saltzberg, Edward Saltzberg & Associates, USA
Robert Shepherd, International Association of Plumbing and Mechanical Officials, USA
Jurg Tester, Schweizerischer Spenglermeister und Installateur-Verband, Switzerland
Murray Thomas, Plumbing Division Manager – PPTC Skills, Western Australia
Richard Wagner, Environmental Engineering, USA
Charles Watson, Curtin University of Technology, Perth, WA, Australia
Andy Watts, Institute of Plumbing and Heating Engineering, United Kingdom
Shiming Zhao, Building Design Institute of the Ministry of Construction, Peoples Republic of China

Index

- access chamber 26, 35, 36, 58, 59, 65, 66, 69, 104, 118, 119, 121
- Aeromonas* 12
- aesthetic 79, 105, 120
- air break 61, 63, 118, 120
- air gap 54, 62, 77, 86, 118, 120
- arsenic 7, 13, 14, 48
- assessment 15, 18, 19, 20, 46, 47
- audit 5, 42
- authority 1, 2, 5, 23, 27, 29, 30, 31, 32, 33, 34, 35, 36, 37, 39, 40, 41, 42, 43, 45, 46, 48, 49, 57, 59, 61, 64, 66, 67, 71, 79, 93, 94, 95, 96, 97, 98, 99, 100, 104, 107, 108, 109, 118, 121
- automobile oil 8
- backflow 5, 25, 27, 54, 57, 60, 61, 62, 68, 71, 77, 79, 80, 85, 86, 87, 88, 90, 91, 93, 94, 96, 97, 106, 113, 118
- backpressure 5, 24, 68, 90, 118, 122
- backsiphonage 5, 24, 57, 60, 61, 68, 73, 85, 86, 87, 88, 90, 96, 106, 113, 118
- bacteria 2, 8, 10, 11, 12, 20, 48, 51, 62, 115
- Bangladesh 13, 14
- biofilms 12, 17
- black water 73, 75, 112, 115, 118
- bleach 7, 37
- boiler 76
- booster pump 4, 71, 72
- bottled water 8, 12, 105
- brass 49, 50, 106
- calcium 17, 37
- Campylobacter* 10
- carbon filter 12
- cement joint 36, 51
- Centers for Disease Control x, 12, 124
- central heating 68, 76
- ceramic filter 104
- certification 5, 24, 40, 41, 42, 44, 45, 46, 47, 48, 54
- check valve 87, 88, 90, 93, 94, 119, 120
- childproof 15
- chloramine 8
- chlordan 87
- chlorinated polyvinylchloride (CPVC) x, 49, 51
- chlorination 7, 15, 51
- chlorine 8, 11, 37, 38, 61, 79, 105
- circulating pump 4
- cistern 37, 62, 63, 74, 77, 111, 119
- clay 36, 53
- clay pipe 36
- climate 6, 112
- code of practice 5, 20, 22, 28, 29, 30, 31, 32, 33, 40, 41, 42, 43, 45, 66, 68, 79, 96, 97, 98, 118
- cold water system 48, 53, 75, 83, 120
- coliform 11
- colour coding 53, 79, 116
- combined sewer 98
- communal systems 22, 24, 58, 67, 103, 105, 107, 108, 113
- concrete 54, 55, 56, 64, 65, 92, 96, 98, 99, 100, 106
- conservation 6, 20, 75, 107, 114, 119
- contamination 2, 4, 5, 6, 7, 8, 9, 11, 12, 13, 14, 15, 18, 19, 20, 24, 32, 37, 55, 60, 61, 62, 67, 68, 71, 85, 88, 90, 91, 103, 108, 110, 113, 115
- control valve 68, 91, 106, 111, 119, 122
- copper 17, 49, 50, 51, 54, 79
- corrosion 13, 17, 20, 24, 48, 49, 50, 51, 72, 78, 119
- cross-connection 4, 5, 20, 24, 40, 42, 53, 55, 75, 77, 78, 79, 80, 81, 82, 85, 86, 90, 97, 106, 113, 116, 119, 124
- Cryptosporidia* 8, 10, 11
- desalination 6
- design of plumbing systems 1, 2, 4, 5, 12, 20, 22, 23, 24, 27, 28, 29, 30, 31, 32, 33, 42, 46, 53, 55, 57, 58, 60, 64, 67, 71, 85, 107, 108
- Dhaka 9

- diameter of water pipes 33, 34, 37, 50, 51, 52, 57, 58, 59, 61, 62, 63, 64, 67, 69, 83, 98, 101, 102, 104, 117, 118
- diarrhoea vii, 6, 7, 12
- disease 5, 6, 9, 10, 11, 14, 21, 105, 108
- disinfection 2, 8, 13, 15, 37, 38, 39, 105, 114, 115, 119
- domestic storage 61, 68
- double check valve 87, 88, 93, 94
- downpipe 99, 119
- Dracunculus medinensis* 11
- drainage system 25, 26, 27, 28, 31, 35, 36, 48, 52, 53, 54, 64, 66, 67, 75, 95, 96, 106, 109, 112, 118, 119, 120, 121, 122
- drainpipe 26, 35, 36, 58, 84
- drains 4, 26, 30, 31, 33, 36, 58, 59, 63, 64, 65, 66, 69, 70, 73, 75, 83, 84, 98, 100, 102, 106, 107, 110, 118, 119
- drinking-water vii, viii, ix, 1, 2, 3, 4, 5, 6, 7, 9, 10, 11, 12, 13, 14, 15, 18, 20, 21, 23, 24, 30, 31, 46, 47, 48, 49, 50, 51, 52, 54, 55, 57, 60, 67, 68, 71, 72, 75, 76, 77, 78, 79, 82, 85, 86, 90, 93, 100, 103, 105, 107, 108, 109, 110, 111, 112, 114, 115, 116, 117, 118, 120, 121
- dual systems 4, 32, 57, 75, 77, 111, 112, 115, 116, 119
- earthenware 52, 54
- electrolysis 78, 119
- enforcement 42, 106, 109, 113
- Entamoeba histolytica* 11
- Escherichia coli* 10, 11, 12, 39
- evaporation 6, 69, 112
- faecal contamination 2, 11, 12, 39, 80
- filtration 2, 8, 115
- fire protection 49, 77, 90
- fixture unit 82, 83, 84, 120
- Flavobacterium* 12
- fluoride 7, 13, 14
- flushing 37, 38, 62, 63, 78, 80, 81, 91, 106, 111, 112, 114, 115, 116, 117, 120, 122
- food 5, 6, 10, 12, 18, 25, 27, 29, 32, 39, 42, 55, 62, 63, 77, 80, 81, 105, 108, 114, 116
- fresh water 6, 90, 114
- frost 58, 61, 69, 120
- galvanized steel 49, 50, 51, 78
- Giardia* 10, 11
- gradient 33, 34, 58, 59, 66, 74, 84, 85, 98, 102
- gravity systems 71, 72, 73, 74, 75, 119, 120, 121
- grease 33, 63, 80, 90, 91, 92, 94, 95, 99, 120
- green water 79, 115, 120
- greywater 69, 73, 74, 75, 79, 114, 115, 117, 119
- groundwater 6, 8, 10, 13, 14, 55, 78, 115, 122
- growth 8, 11, 12, 16, 50, 62, 76
- Guidelines for Drinking-water Quality 11, 12, 15, 19, 47, 49, 120, 124
- hazard assessment 18, 19
- health vii, viii, 1, 2, 3, 4, 5, 6, 10, 11, 12, 13, 15, 16, 17, 20, 22, 23, 24, 25, 27, 28, 29, 30, 32, 39, 41, 42, 45, 48, 49, 53, 63, 64, 67, 75, 79, 80, 81, 87, 98, 103, 104, 105, 107, 108, 119, 120, 121, 122
- helminthes 11
- Hepatitis* 10, 11
- heterotrophic plate count (HPC) x, 12, 121
- heterotrophs 11, 12
- horizontal drain 59, 65, 66, 67, 84, 101, 102, 119, 122
- hospital 4, 12, 13, 19, 38, 59, 75, 76, 81, 85, 88, 108, 110
- hot water system 12, 15, 25, 48, 50, 57, 68, 72, 75, 76, 77, 78, 79, 83, 111, 120
- hotel 5, 19, 38, 42, 58, 67, 68, 69, 75, 76, 80, 108, 111
- household water treatment 7, 105
- hydration 6, 7
- hydropneumatic tank 72
- hygiene vii, 6, 7, 19, 24, 103, 104, 105, 121
- hypochlorite 37, 79
- immunocompromised 12, 13
- industrial premises 5, 6, 9, 25, 40, 41, 42, 54, 55, 57, 59, 77, 80, 81, 85, 94, 95, 96, 109, 111
- infection 10, 12, 13, 115
- infiltration 36, 107, 108
- inspection 5, 26, 29, 40, 41, 42, 43, 58, 62, 64, 66, 78, 93, 100, 106, 107, 108, 109, 113, 120
- intermittent supply 112
- iodine 105
- iron 16, 49, 50, 51, 54
- irrigation 5, 6, 52, 75, 77, 81, 85, 112, 114, 115, 116, 122

- jurisdiction 29, 30, 31, 32, 45, 67, 104
Klebsiella 12
 latrines 10, 96, 105, 106, 113
 laundry 6, 24, 55, 58, 67, 103, 114, 115, 120
 lead pipe 13, 20, 21
 leakage 1, 8, 23, 24, 25, 35, 39, 52, 54, 62, 63, 65, 75, 77, 107, 108, 109, 110
Legionella 11, 12, 15, 76
 liability 22, 41
 licence, licensing 29, 31, 34, 35, 42, 45, 98
 liquid seal trap 26
 liquid waste 1, 3, 4, 20, 23, 25, 68, 119, 120, 121, 122
 lodging house 5, 42, 108
 mains 1, 2, 4, 5, 13, 23, 24, 32, 35, 38, 42, 52, 60, 61, 67, 68, 71, 72, 76, 77, 86, 96, 100, 104, 106, 107, 108, 109, 110, 113, 120, 121, 122
 maintenance 1, 5, 16, 23, 27, 28, 34, 38, 39, 54, 57, 58, 59, 62, 66, 68, 74, 78, 82, 93, 106, 107, 108, 109, 113
 management 1, 2, 3, 10, 15, 17, 18, 19, 20, 23, 24, 43, 54, 109, 114, 115
 materials 17, 20, 21, 23, 24, 25, 27, 28, 29, 31, 36, 37, 40, 41, 46, 47, 48, 49, 50, 52, 53, 54, 55, 56, 57, 64, 67, 78, 90, 98, 107, 108, 111
 metering 107, 109, 110
 microorganisms 2, 8, 10, 11, 12, 13, 14, 17, 63
 mixing valve 15, 16, 75, 120
 multiple barriers 2, 7, 18
 multiple dwelling 57, 67, 68, 73, 76, 77, 82, 109, 113
 multi-storey building 4, 36, 41, 57, 71, 72, 73, 77
Mycobacterium avium 16
 negative pressure 5, 26, 68, 73, 113, 120
 nitrate/nitrite 13, 14
 non-testable device 93
Norovirus 10, 11
 odour 8, 12, 26, 51, 63, 64, 65, 79, 87
 one-pipe system 64, 68, 69
 overflow 25, 54, 61, 62, 63, 77, 85, 96, 99, 101, 109, 120
 pathogens 2, 8, 9, 10, 11, 80, 114
 penalties 31, 32, 40, 42
 pesticide 8, 13, 79, 87, 96
 pH 16, 48, 95, 121
 plastic piping 49, 51, 52, 53, 54, 55, 65
 plumber 1, 2, 16, 20, 21, 23, 28, 29, 31, 33, 34, 35, 36, 37, 40, 41, 42, 44, 45, 47
 plumbing fixture 24, 33, 40, 54, 55, 58, 59, 61, 62, 63, 66, 67, 73, 77, 83, 84, 85, 103, 110, 118, 112, 120, 121
 point of use 2, 7, 16, 111
 polybutylene 49, 50, 51
 polyethylene x, 49, 52
 polyvinylchloride (PVC) x, 49, 51, 52, 53, 54
 pressure 5, 8, 23, 24, 25, 26, 35, 36, 37, 38, 42, 48, 51, 52, 61, 63, 64, 67, 68, 71, 72, 73, 75, 76, 77, 82, 85, 86, 87, 88, 90, 91, 93, 96, 106, 107, 108, 110, 111, 113, 114, 118, 120, 121, 122
 prevention 7, 18, 19, 42, 54, 60, 61, 68, 77, 78, 79, 80, 85, 93, 94, 97, 107, 119
 privy 105, 106
 protozoa 8, 10, 11, 98
Pseudomonas 11, 12, 15
 public health 1, 2, 5, 10, 11, 15, 20, 27, 41, 42, 75, 103, 108
 public water supply 2, 3, 5, 7, 30, 31, 32, 34, 60, 71, 72
 qualifications 29, 31, 41
 quality 1, 2, 6, 7, 11, 17, 18, 20, 21, 23, 24, 27, 28, 31, 46, 47, 49, 53, 54, 56, 77, 79, 98, 100, 104, 105, 107, 114, 115, 116, 122
 radon 13
 rainfall 99, 100, 101, 102, 122
 reclaimed water 79, 115, 116, 117, 120, 121
 registration 34, 40, 44, 45, 91
 reuse 6, 115, 112
 roof 9, 25, 26, 62, 64, 65, 69, 71, 73, 78, 98, 99, 100, 101, 102, 106, 118, 119, 122
Rotavirus 11
 runoff 8, 10, 14, 16, 99
 salmonellae 11
 sanitary waste 1, 8, 24, 94
 sanitation vii, viii, 3, 6, 7, 45, 91, 103, 105, 114
Sapovirus 11
 SARS 3
 scalding 12, 15, 16, 75
Schistosoma 11

- self-certification 5, 41, 42
septic tank 8, 10, 14, 26, 34, 43, 80, 94, 104, 106
Serratia 12
sewage 1, 3, 9, 11, 12, 14, 18, 26, 27, 54, 69, 73, 85, 90, 94, 95, 96, 99, 106, 107, 108, 110, 114, 115, 117, 118, 119, 120, 121, 122
sewerage 1, 2, 3, 26, 27, 28, 29, 31, 32, 34, 35, 43, 66, 73, 74, 75, 86, 90, 96, 99, 103, 107, 108, 115, 120, 122
shellfish 10
Shigella 11
shut-off valve 57, 60, 86, 87, 90
single dwelling 57, 58, 60, 64, 67, 75, 109
single-stack system 69
soakaway 98, 99, 100, 122
specification 1, 15, 24, 28, 34, 35, 46, 47, 49, 57, 76
stack pipe 64, 65, 66, 69
standards 15, 18, 21, 23, 27, 28, 29, 30, 34, 44, 45, 46, 47, 48, 49, 53, 54, 79, 100, 108, 114, 120
standpipe 8, 24, 96, 103, 104, 105, 106, 113
stop valve 61, 68, 113, 121
storage tank 11, 37, 38, 39, 61, 62, 68, 71, 72, 75, 77, 79, 98, 100, 106, 113, 118, 122
storm water 33, 34, 51, 53, 57, 80, 95, 96, 98, 100, 107, 119, 122
supply vii, 1, 2, 3, 4, 5, 6, 7, 9, 10, 13, 18, 20, 21, 23, 24, 28, 30, 31, 37, 38, 42, 48, 49, 50, 53, 54, 55, 57, 58, 60, 61, 63, 67, 68, 71, 72, 75, 76, 77, 78, 79, 80, 81, 82, 83, 86, 90, 91, 93, 94, 100, 103, 104, 105, 107, 108, 109, 110, 111, 112, 113, 117, 118, 119, 121
surface water 6, 10, 13, 14, 78, 96, 99, 100, 122
tap 2, 7, 8, 12, 15, 16, 18, 23, 25, 37, 38, 48, 49, 54, 55, 62, 80, 87, 96, 98, 100, 104, 107, 109, 111, 113
temperature 7, 12, 15, 16, 17, 25, 51, 52, 53, 54, 60, 75, 76, 78, 79, 90, 111, 112, 121, 122
testable device 93
testing 4, 5, 27, 35, 36, 37, 41, 42, 46, 47, 81, 82
toilet 4, 25, 54, 55, 74, 109, 111, 112, 114, 115, 122, 123
training 19, 21, 23, 27, 33, 43, 44, 45, 48, 49, 55, 105, 114
trap 3, 26, 33, 36, 54, 62, 64, 66, 68, 69, 70, 73, 80, 90, 91, 94, 99, 112, 118, 120, 121, 122
treatment 1, 2, 3, 7, 8, 10, 12, 13, 18, 19, 23, 25, 26, 49, 52, 56, 75, 85, 88, 94, 95, 99, 105, 110, 114, 115, 120, 122
two-pipe system 66, 68
typhoid 11
urinal 25, 55, 59, 67, 83, 85, 112, 115
vacuum systems 72, 74, 75
velocity (in pipe) 50, 58, 59, 67, 73, 74
vent pipe 53, 65, 69, 73
ventilation 3, 25, 64, 65, 69, 70, 93
Vibrio cholerae 11
virus 8, 10, 11, 115
vitrified clay 53
wastage 1, 24, 107, 108, 109, 110, 112, 113
waste 1, 2, 3, 4, 6, 8, 9, 10, 11, 15, 17, 20, 23, 24, 25, 26, 34, 37, 43, 51, 53, 63, 68, 70, 73, 80, 90, 94, 95, 98, 99, 100, 103, 107, 108, 110, 114, 118, 119, 120, 121, 122
wastewater 3, 4, 16, 24, 25, 26, 28, 48, 49, 54, 63, 66, 69, 73, 75, 80, 99, 103, 107, 109, 114, 115, 122
water closet 4, 24, 25, 38, 59, 62, 63, 64, 65, 66, 67, 68, 69, 83, 84, 106, 112, 114, 116, 122
water hammer 16, 113
water heater 12, 16, 52, 59, 76, 111
water safety plan (WSP) x, 2, 18, 19
World Health Organization (WHO) vii, viii, ix, x, 2, 3, 14, 18, 23, 48, 105, 114
Yersinia enterocolitica 11