

# Biogas Stove Design

A short course



Dr David Fulford

Kingdom Bioenergy Ltd

Originally written August 1996

Used in MSc Course on "Renewable Energy and the Environment" at the University of Reading, UK for an Advanced Biomass Module.

## Design Equations for a Gas Burner

The force which drives the gas and air into the burner is the pressure of gas in the pipeline. The key equation that relates gas pressure to flow is Bernoulli's theorem (assuming incompressible flow):

$$\frac{p}{\rho} + \frac{v^2}{2g} + z = \text{constant}$$

where:  $p$  is the gas pressure ( $\text{N m}^{-2}$ ),  
 $\rho$  is the gas density ( $\text{kg m}^{-3}$ ),  
 $v$  is the gas velocity ( $\text{m s}^{-1}$ ),  
 $g$  is the acceleration due to gravity ( $9.81 \text{ m s}^{-2}$ ) and  
 $z$  is head (m). For a gas, head ( $z$ ) can be ignored.

Bernoulli's theorem essentially states that for an ideal gas flow, the potential energy due to the pressure, plus the kinetic energy due to the velocity of the flow is constant

In practice, with gas flowing through a pipe, Bernoulli's theorem must be modified. An extra term must be added to allow for energy loss due to friction in the pipe:

$$\frac{p}{\rho} + \frac{v^2}{2g} - f(\text{losses}) = \text{constant}.$$

Using compressible flow theory, flow through a nozzle of area  $A$  is:

$$\dot{m} = C_d \rho_0 A \sqrt{2 \left( \frac{\gamma}{\gamma-1} \right) \frac{p_0}{\rho_0} r^{2/\gamma} \left( 1 - r^{(\gamma-1)/\gamma} \right)}$$

where  $p_0$  and  $\rho_0$  are the pressure and density of the gas upstream of the nozzle and  $r = p_1/p_0$ , where  $p_1$  is the pressure downstream of the nozzle.

### **Injector orifice or jet**

The amount of gas used by a burner is controlled by the size of the gas "jet" or "injector orifice" (an orifice is a hole in a plate). This is usually a brass thimble with a hole drilled in the end, screwed onto the end of the gas line fitting, so that it can be easily replaced. As well as controlling the gas flow rate, the injector has the second important role of separating the burner from the gas supply. It should be impossible for a flame to enter the gas supply pipe.

Injectors on larger burners may have more than one hole, mainly to reduce noise.

The gas flow rate ( $Q$ ) is related to the gas velocity ( $v$ ) by the area ( $A$ ) of the pipe through it is flowing:

$$Q = v A$$

For gas flow through an orifice, the area of the hole is not necessarily the area of the flow. A sudden change in flow area causes a “vena contracta”, a narrowing of the flow to an area smaller than that of the hole itself:

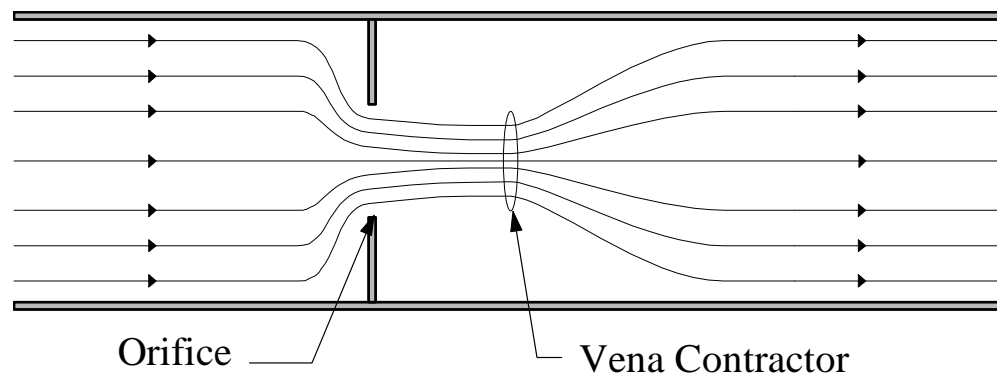

An orifice plate can be used to measure gas flow over a very wide range of flow conditions, including very high flow rates.

### Gas flow through an injector orifice (jet)

An empirical version of Bernoulli's theorem is used to define the flow rate:

$$Q = 0.0467 C_d A_0 \sqrt{\frac{p}{s}}$$

where:  $Q$  = gas flow rate ( $\text{m}^3 \text{h}^{-1}$ ),

$A_0$  = area of orifice ( $\text{mm}^2$ )

$p$  = gas pressure before orifice (mbar)

$s$  = specific gravity of gas

$C_d$  = coefficient of discharge for the orifice.

The coefficient of discharge for the orifice takes into account the vena contractor and friction losses through the orifice. It usually has a value between 0.85 and 0.95.

## Orifice design

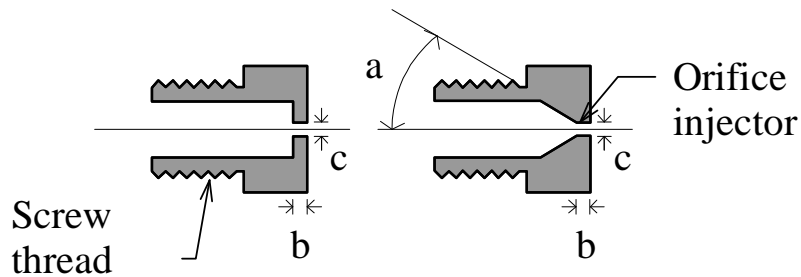

To maximise  $C_d$ , the angle ( $a$ ) of approach before the orifice should be  $30^\circ$  and the length of the orifice channel ( $b$ ) should be between 1.5 and 2 times the orifice diameter ( $c$ ).

To ensure accuracy, each jet is usually calibrated individually using a fixed pressure air supply and a flow meter and its value of  $C_d$  marked on it.

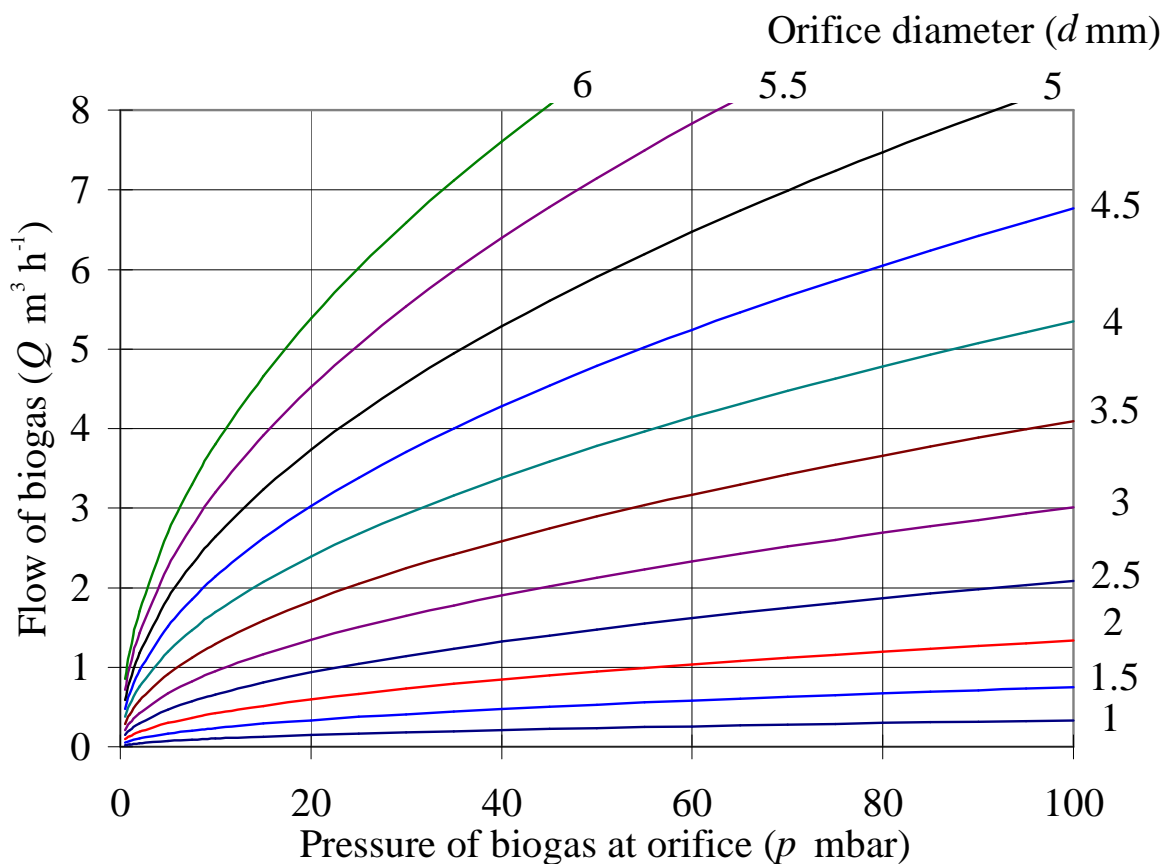

Graph of:  $Q = 0.036 C_d d^2 \sqrt{\frac{p}{s}}$  where  $d$  is the orifice diameter (mm)

$C_d$  is taken as 0.9.

## Biogas Combustion

Biogas burns in oxygen to give carbon dioxide and water:

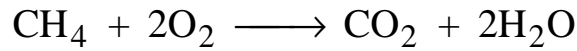

One volume of methane requires two volumes of oxygen, to give one volume of carbon dioxide and two volumes of steam.

Since there is 58% methane in biogas and 21% oxygen in air:

$$\frac{1}{0.58} = 1.72 \text{ volumes of biogas require } \frac{2}{0.21} = 9.52 \text{ volumes of air,}$$

or: 1 volume of biogas requires  $\frac{9.52}{1.72} = 5.53$  volumes of air or

$$\frac{1}{1 + 5.53} = 0.153 = 15.3\% \text{ biogas in air (stoichiometric air requirement).}$$

Biogas will burn over a fairly narrow range of mixtures from 9% to 17% biogas in air.

If the flame is “too rich”, has too much fuel, then it will burn badly and incompletely, giving carbon monoxide (which is poisonous) and soot (carbon particles).

Burners are usually run “slightly lean”, with a small excess of air, to avoid the danger of the flame becoming rich.

In most burners, air is mixed with the gas before it is burnt in a flame (pre-aeration). Post-aerated flames, where the gas is ignited at the end of the gas line, give very poor combustion.

The amount of “primary air” added to the gas before the flame, varies depending on the design of burner, but is usually around 50% of the total air requirement.

## Flames

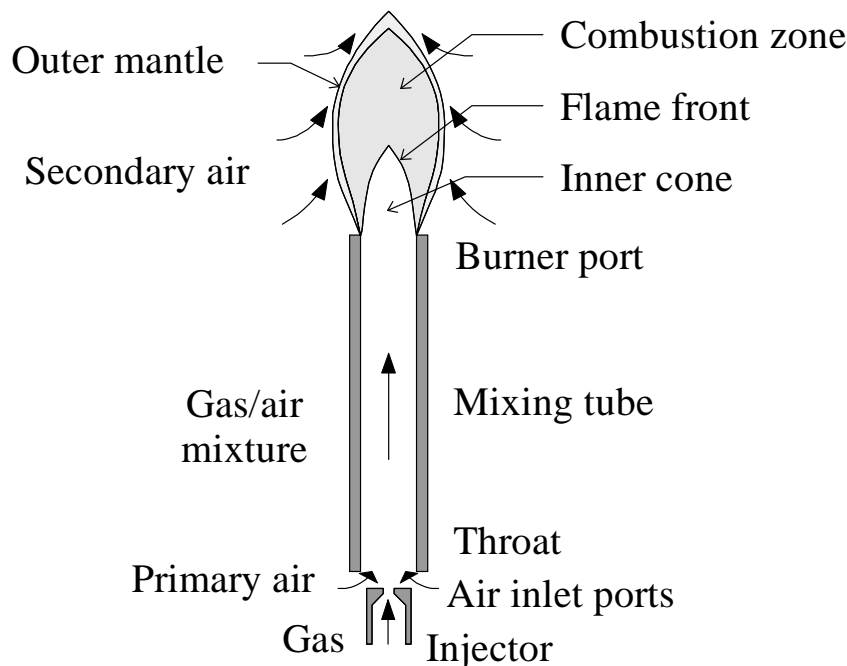

As gas comes out of the injector, air is “entrained” into the stream and is mixed in the mixing tube with the gas before it comes out of the burner port. The unburned gas is heated up in an “inner cone” and starts burning at the “flame front”. The cone shape is a result of laminar flow in a cylindrical mixing tube, the mixture at the centre of the tube is moving at a higher velocity than that at the outside.

The main “combustion zone” is where the gas burns in the primary air and generates the heat in the flame. The “Outer mantle” of the flame is where combustion is completed with the aid of the secondary air that is drawn into the flame from the sides.

The combustion products (carbon dioxide and steam) are at a high temperature, so rise vertically away from the flame, transferring heat to the air close to the top of the flame. It is this air moving vertically away that draws in the cooler secondary air to the base of the flame.

The size of the inner cone depends on the primary aeration. A high proportion of primary air makes the flame much smaller and concentrated, giving higher flame temperatures.

## Entrainment

The gas emerging from the injector enters the end of the mixing tube in a region called the “throat”. The throat has a much larger diameter than the injector, so the velocity of the gas stream is much reduced.

The velocity ( $v_0$ ) of the gas in the injector orifice is given by:

$$v_0 = \frac{Q}{3.6 \times 10^{-3} A_0} \text{ m s}^{-1}, \text{ with } Q \text{ in m}^3 \text{ h}^{-1} \text{ and } A_0 \text{ in mm}^2.$$

while the velocity in the throat is reduced to:

$$v_t = v_0 \frac{A_0}{A_t} = v_0 \frac{d_0^2}{d_t^2}$$

ignoring the vena contractor and friction.

The gas pressure just after the nozzle then becomes:

$$p_t = p_0 - \rho \frac{v_0^2}{2g} \left[ 1 - \left( \frac{d_0}{d_t} \right)^4 \right]$$

The value of  $p_0$  is around atmospheric pressure, as the throat is open to the air, so this drop in pressure is sufficient to draw primary air in through the air inlet ports to mix with the gas in the mixing tube.

The primary aeration depends on the “entrainment ratio” ( $r$ ), which is determined by the area of the throat and the injector:

$$r = \sqrt{s} \left( \sqrt{\frac{A_t}{A_0}} - 1 \right) = \sqrt{s} \left( \frac{d_t}{d_0} - 1 \right) \quad (\text{Prigg's formula})$$

where  $A_t$  and  $d_t$  are the area and diameter of the throat and  $A_0$  and  $d_0$  are the area and diameter of the injector.

Prigg's formula holds if the total flame port area ( $A_p$ ) is between 1.5 and 2.2 times the area of the throat. This ratio is approximately independent of the gas pressure and the flow rate. The primary air supply is rarely enough to give a stoichiometric mixture.

## Throat size

The flow rate of the mixture in the throat ( $Q_m$ ) is then given by:

$$Q_m = \frac{Q(1+r)}{3600} \text{ with } Q_m \text{ in m}^3 \text{ s}^{-1} \text{ and } Q \text{ in m}^3 \text{ h}^{-1}.$$

The pressure drop due to the flow of the mixture down the mixing tube should be checked, by first calculating the Reynolds number:

$$Re = \frac{\rho d_t v_t}{\mu} = \frac{\rho d_t}{\mu} \frac{4Q_m}{\pi d_t^2} = \frac{4\rho Q_m}{\pi\mu d_t}$$

where  $\rho$  and  $\mu$  are the density and viscosity for the mixture (use  $\rho = 1.15 \text{ kg m}^{-3}$  and  $\mu = 1.71 \times 10^{-5} \text{ Pa s}$  at  $30^\circ\text{C}$ ).

The pressure drop ( $\Delta p$ ) is then given by:

$$\Delta p = \frac{f}{2} \rho v_t^2 \frac{L_m}{d_t} = \frac{f}{2} \rho \frac{16Q_m^2}{\pi^2 d_t^5} L_m$$

where  $f = \frac{64}{Re}$ , when  $Re < 2000$  and  $f = \frac{0.316}{Re^{1/4}}$  when  $Re > 2000$

The pressure drop should be much less than the driving pressure.

Most burners are designed to have a throat that gives an aeration greater than optimum, with a device for restricting the air flow, so the optimum aeration can be set for a given situation:

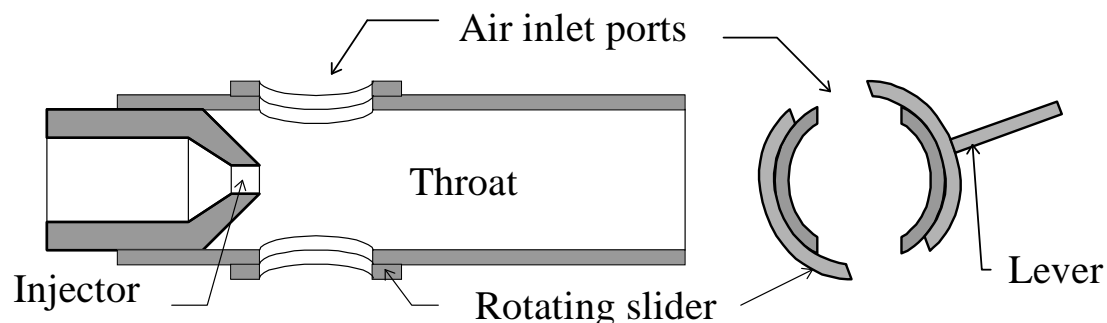

A simple method of air control on a cylindrical mixing tube is to make the air inlet ports as holes in the cylinder wall, at right angles to the length of the cylinder. These holes should be horizontal, rather than vertical, to prevent gas seeping out at low flow rates. The holes can be partially covered by a concentric section of cylinder, with identical holes in it, that can be rotated by a lever. The maximum area of the holes should be larger than the cross-sectional area of the throat.



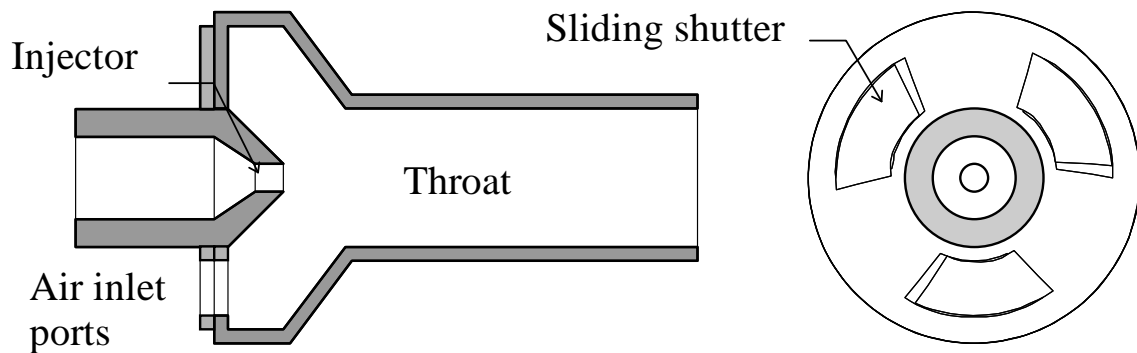

A more complex method to do the same job is to make slots in a flat disk that fits behind the gas injector.

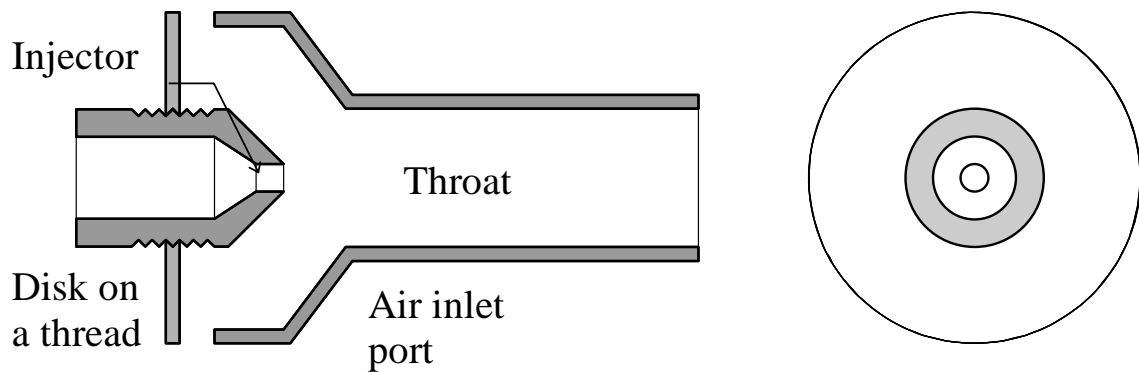

or to mount a disk on a thread on the injector pipe, so the air port can be opened and closed by rotating the disk up and down the screw.

## Mixing tube

For a cylindrical throat, the mixing tube must be long enough to allow good mixing of the gas and air. A length of  $10 \times d_t$  is usually recommended.

## Venturi

Another way of making the mixing tube is as a “venturi” or “diffuser”, with a pipe that tapers into the throat and tapers smoothly away again:

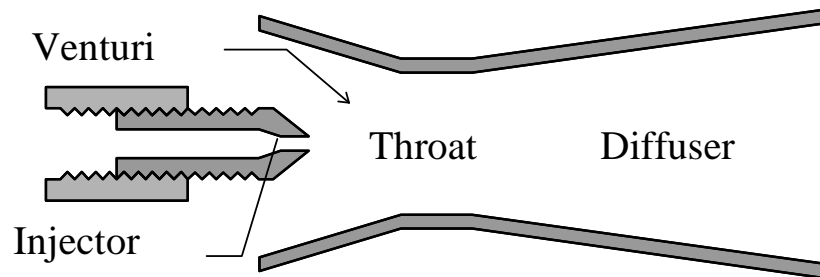

The air flow can be adjusted by screwing the injector into or out of the throat, or by moving the throat relative to the injector.

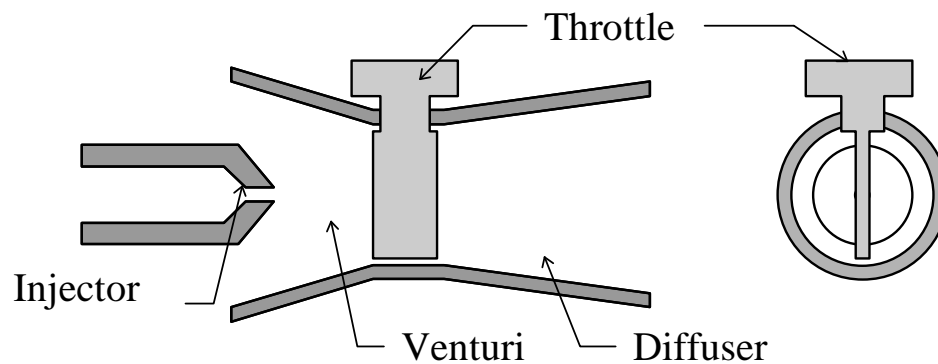

The air flow in the venturi can also be controlled by fitting a “throttle”, either a vane that can be turned or a screw that can be screwed in to block the throat.

A venturi can be shorter than a cylindrical mixing tube ( $6 \times d_p$ ), so is often used where space is limited, such as in lamps.

## Burner ports

The big advantage of a gas burner is that the heat can be directed to where it is needed, by designing the burner properly. However, the design must allow for particular problems that can occur when burning gas, especially biogas.

## Lighting back

It is possible for the flame at a burner port to travel back down the mixing tube to the injector. This is called “lighting back”.

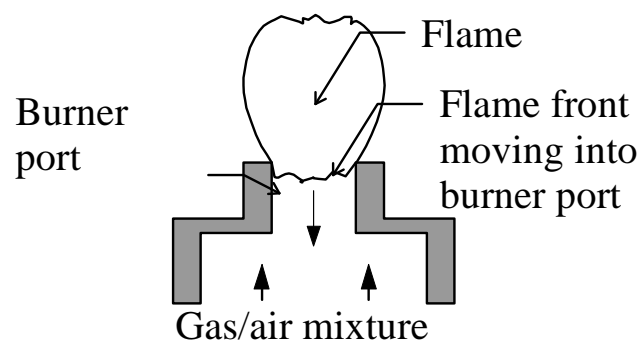

The way to overcome lighting back is to choose a burner port size smaller than a certain size. For ports in thin metal, this will be 2.5 mm diameter for natural gas. If the burner port is drilled in thicker metal, then it can be larger.

Because biogas has such a low flame speed, lighting back is not usually a problem. 5 mm diameter holes in 5 mm thick metal do not seem to light back.

## Flame lift

The opposite effect is a real problem with biogas, that of the flame lifting off the burner port:

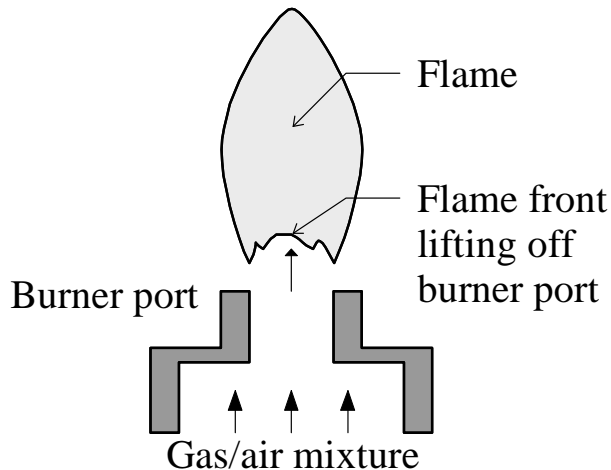

The flame lifts off from the port and can “blow-off” and go out. “Flame lift” occurs when the speed of the gas/air mixture through the burner port is higher than the speed of the flame burning in the gas. Biogas has a stoichiometric flame speed of only  $0.25 \text{ m s}^{-1}$ , so the total flame port area must be chosen so that the mixture velocity through the ports is much lower than this figure. The flame velocity at the flame front is likely to be 50% of the stoichiometric value, as the flame is not fully aerated at this point.

Even if the burner port size is designed correctly for a particular situation, a variation in conditions can result in flame lift. Alterations in the entrainment ratio, caused by adjustments in the primary air controls, or by partial blockage of the air inlets by dirt, can cause the flame velocity at the flame front to change. Increased supply pressure will increase the mixture flow rate and velocity, also causing flame lift.

The mixture supply velocity ( $v_p$ ) is given by:

$$v_p = \frac{Q_m}{A_p} \ll 0.25 \text{ m s}^{-1}, \text{ with } Q_m = \frac{Q(1+r)}{3600} \text{ in } \text{m}^3 \text{ s}^{-1}. \text{ and}$$

$$A_p, \text{ the total burner port area in } \text{m}^2, = n_p \frac{\pi d_p^2}{4}$$

where:  $n_p$  is the number of ports, each of diameter  $d_p$  in m.

## Burner manifold

The flow of the gas/air mixture through each of the burner ports must be uniform, so each burner port should be of the same size. Also the pressure drop in the supply pipes leading to the burner ports must be of the same value. The usual way to ensure this is to use a manifold that is symmetrical and with a cross-sectional area that is much larger than the total flame port area:

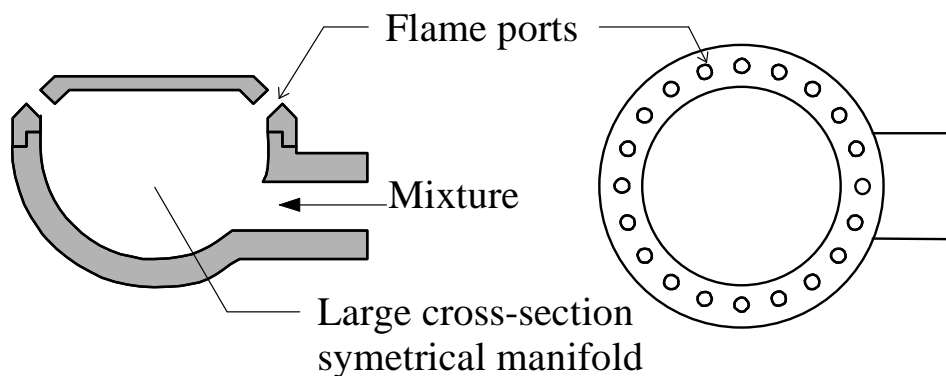

For a bar burner, with the flame ports arranged in line on a cylindrical or rectangular tube, it is common to place the mixing tube so the mixture comes out at the centre of the manifold:

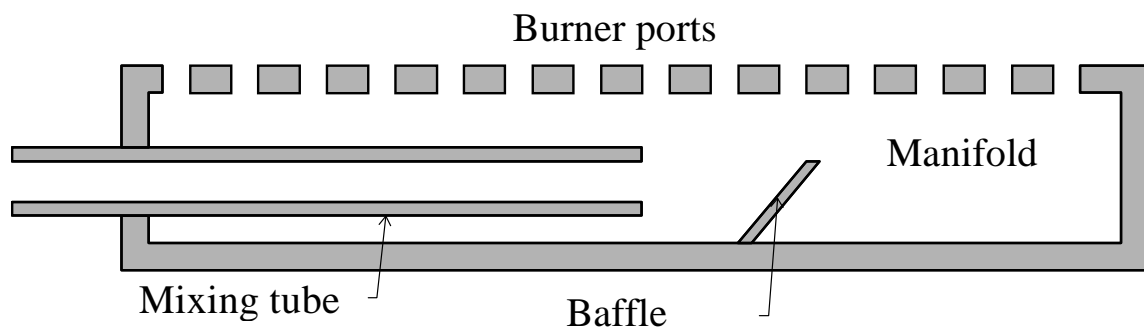

Baffles may be required to balance the flow patterns within the manifold, so the flame size is uniform.

Burner ports are often round in shape, but can be made any shape. Burner bars often use slotted ports, as they give fan shaped flames. "Ribbon" burners are made by placing alternate strips of flat and corrugated metal strips together:

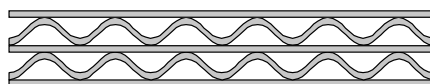

## Burner port design

The total area of the burner ports is limited by the need to prevent flame lift, as above. It can also be defined by the heat output from the burner ports, which should be less than  $900 \text{ W cm}^{-2}$  ( $0.09 \text{ W m}^{-2}$ ) of burner port area.

The size and positioning of the individual burner ports are defined by various factors, such as the heat pattern required, the need for burner ports to be close enough together for cross-lighting and the need for an adequate supply of secondary air.

Domestic stoves, used mainly for cooking, usually have burner ports arranged in a circular pattern, as most cooking pots have a circular base. The size of the circle depends on the average size of the cooking pots to be used. Water heaters usually use one or more bar burners arranged under a rectangular boiler.

## Cross-lighting

A burner is usually lit at one place, so the flames should jump from one burner port to the next, so the whole burner is alight. Also the flames at individual burner ports may go out, so cross-lighting is essential.

For biogas, the gaps between burner ports should be around 5 mm to ensure cross-lighting occurs.

## Secondary air supply

The pattern of burner ports should allow secondary air to reach each port without interference.

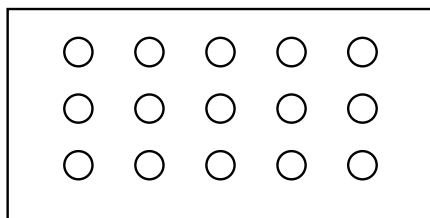

Secondary air unable to reach holes at centre

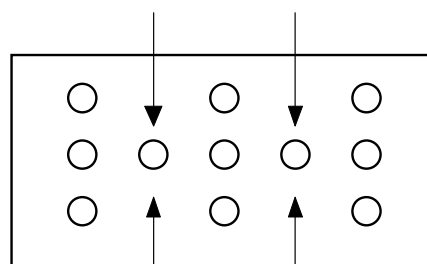

Secondary air able to reach all holes

The first pattern would produce a poor burning pattern, with the flames from the central burner ports being much higher than those at the edge because secondary air is prevented from reaching them. The second pattern allows air to reach each of the burner holes.

## Flame stabilisation

Several methods can be used to reduce the problem of flame lift. The supply of secondary air to the flame can be increased by putting the burner ports in a raised ledge, or by putting them at an angle to the horizontal:

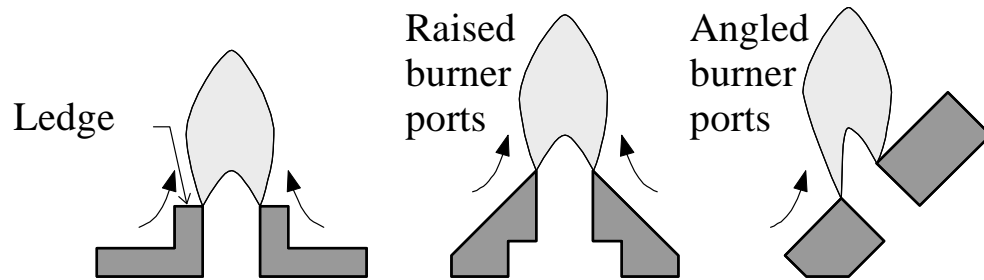

The second method uses retention flames, small flames arranged around the main flame to hold it onto the burner port. The velocity of the mixture entering these smaller burner ports is often reduced by increasing the friction losses into these ports, using “metering orifices”:

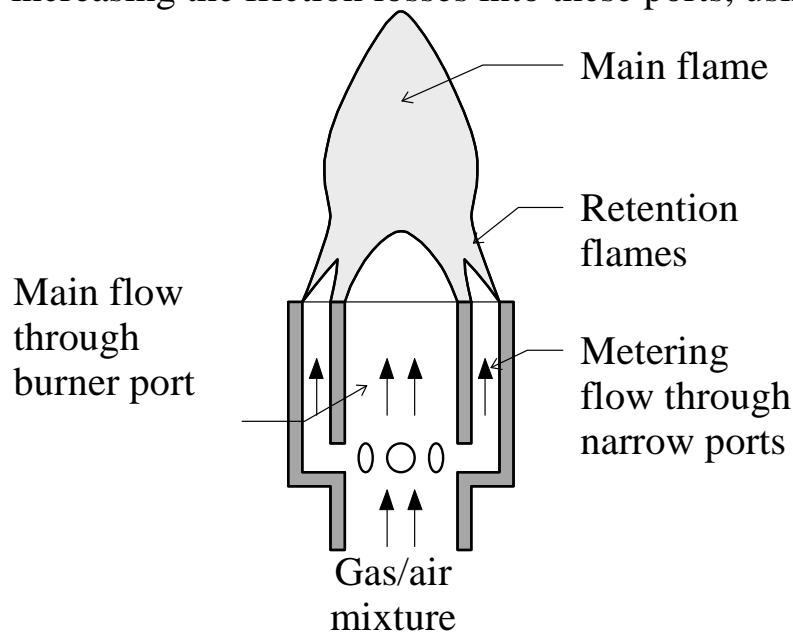

The third method uses sudden changes in flow area at the burner port to give eddies, that help in flame stabilisation:

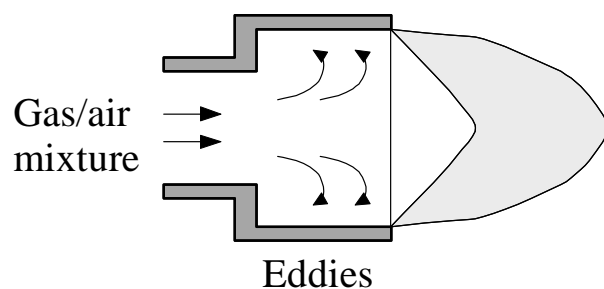

## **Pot supports**

The gas in a flame must be at a high temperature for the combustion reaction to proceed. If the flame is cooled, the reactions are “quenched” and the reactions are incomplete. Biogas burning in air will produce carbon monoxide and carbon particles (soot) if the reaction is quenched.

Quenching is useful, as it prevents lighting back in burner ports that are of the correct size. The flame cannot pass through the port as the metal cools it.

The correct positioning of the object to be heated (e.g. a pot of food to be cooked) above the flame is therefore important. If the object is too close to the flame, the flame is quenched and the combustion is incomplete and the efficiency of the stove is reduced. If the object is too far away from the flame, heat is lost to the atmosphere and the stove is again less efficient.

The best position for the base of the object being heated is just above the tip of the visible flame, just outside the outer mantle, above the hottest part of the flame.

The flame height, though, depends on a variety of factors. A key variable is the velocity of the gas/air mixture through the burner ports, which in turn depends on the size of the burner ports and the gas pressure. The degree of primary aeration of the burner affects both the mixture velocity and the height of the inner cone of the flame, which in turn affects the full flame height. Greater primary aeration will reduce the flame height.

In practice, the position of the object to be heated needs to be designed once a prototype burner has been made and the flame length for typical conditions has been measured. The design of the pot support height for domestic stoves, for example, may need to be left until the rest of the stove can be made and tested.

A typical value for the height between the flame ports and the pot base was 25 to 30 mm for 5 mm burner ports, using biogas at 10 mbar pressure. Smaller flame ports should lead to shorter flames.



Biogas appliance	Power supply (kW)	Biogas consumption (10 mbar) (m <sup>3</sup> h <sup>-1</sup> )
Gas lamp	0.8	0.18
'fridge burner	0.8	0.18
Domestic burners	1.2 to 5.5	0.3 to 1.2
Commercial burners	5.5 to 17	1.2 to 4
Dual-fuel engines	per kW out	0.56
Spark engines	per kW out	0.7

Gas consumption of various biogas appliances

### Typical calculation - DCS stove

The DCS stove was designed to supply about 1.5 kW for cooking. Assuming that it is 55% efficient, it requires a heat output of 2.72 kW or 9.8 MJ h<sup>-1</sup>. The biogas flow rate required is then:  $\frac{9.8}{20.8} = 0.471 \text{ m}^3\text{h}^{-1}$ .

Using a suitable injector with a  $C_d$  of 0.9, and a gas supply pressure of 10 mbar (= 102 mm water gauge), the injector size is:

$$d_0 = \sqrt{\frac{Q}{0.036 C_d}} \sqrt[4]{\frac{s}{p}} = \sqrt{\frac{0.471}{0.0324}} \sqrt[4]{\frac{0.94}{10}} = 2.1\text{mm}$$

The velocity of gas in the orifice is:  $v_0 = \frac{Q}{3.6 \times 10^{-3} A_0} = 37.8 \text{ m s}^{-1}$ .

If the stoichiometric air requirement is 5.5, then the entrainment ratio  $r$  should be  $5.5/2 = 2.75$ .

Using Prigg's formula:  $d_t = \left(\frac{r}{\sqrt{s}} + 1\right) d_0 = \left(\frac{2.75}{\sqrt{0.94}} + 1\right) \times 2.1 = 8.1\text{mm}$ .

However, it is better to increase this value to give an aeration much greater than optimum and then use air controls to adjust the air flow.

A suitable value for the throat diameter might be 14 mm, giving a maximum possible aeration of  $r = \sqrt{0.94} \left(\frac{14}{2.1} - 1\right) = 5.5$ , which is

stoichiometric. However, the exact size depends on the standard pipe sizes available.

The throat area then becomes:  $153.9 \text{ mm}^2$  or  $1.54 \times 10^{-4} \text{ m}^2$ .

The air inlet ports must have an area similar to that of the throat.

The gas pressure in the throat can be calculated:

$$p_t = p_0 - \rho \frac{v_0^2}{2g} \left[ 1 - \left( \frac{d_0}{d_t} \right)^4 \right]$$

$$= 10^5 - 1.0994 \frac{37.8^2}{2 \times 9.81} \left[ 1 - \left( \frac{2.1}{14} \right)^4 \right] = 10^5 - 80 \text{ Pa}$$

The mixture flow rate at optimum aeration is:

$$Q_m = \frac{Q(1+r)}{3600} = \frac{0.471(1+2.75)}{3600} = 4.91 \times 10^{-4} \text{ m}^3\text{s}^{-1}.$$

The pressure drop in the mixing tube, which should be at least 140 mm long ( $10 \times d_t$ ), can be calculated:

$$Re = \frac{4 \rho Q_m}{\pi \mu d_t} = \frac{4 \times 1.15 \times 4.91 \times 10^{-4}}{\pi \times 1.71 \times 10^{-5} \times 0.014} = 3003$$

$Re > 2000$ , so  $f = \frac{0.316}{Re^{1/4}} = \frac{0.316}{3003^{1/4}} = 0.0427$  and

$$\Delta p = \frac{f}{2} \rho \frac{16 Q_m^2}{\pi^2 d_t^5} L_m$$

$$= 0.0427 \times 1.15 \times \frac{8 \times (4.91 \times 10^{-4})^2}{\pi^2 \times 0.014^5} \times 0.14 = 2.5 \text{ Pa}$$

This is much lower than the driving pressure in the throat (80 Pa).

The total burner port area can now be chosen:

$$A_p > \frac{Q_m}{0.25} > \frac{4.91 \times 10^{-4}}{0.25} > 0.00196 \text{ m}^2, \text{ say } 0.002 \text{ m}^2.$$

Using 5 mm diameter holes, the total number required will be:

$$n_p = \frac{4 A_p}{\pi d_p^2} = \frac{4 \times 0.002}{\pi \times 0.005^2} = 102$$

Using flame stabilisation, it should be possible to reduce this number of burner ports, by up to  $\frac{1}{5}$ , so 20 holes may be sufficient.

The DCS stove does use 20 holes at 5 mm diameters (total burner port area =  $3.9 \times 10^{-4} \text{ m}^2$ ), set at  $45^\circ$  to the vertical and the flames are fairly stable. A larger burner port area would allow for greater flame stability.

Using 20 holes, with 5 mm gaps between holes, arranged in a circular pattern, gives a total circumference of  $20 \times (5 + 5) = 200 \text{ mm}$ . The holes centres are then placed around a circle of diameter 64 mm. Using more burner ports of the same diameter would mean a larger circle and a larger area over which the heat is distributed. Alternatively, the same area could be used, by making the burner ports bigger:  $20 \times 7 \text{ mm}$  diameter ports would give a burner port area of  $7.7 \times 10^{-4} \text{ m}^2$  (about twice) and 3 mm gaps between the holes.

There is always a certain amount of trial and error in finalising the burner design. It is useful to make the prototype so that different parts can easily be removed and altered

### **Materials of construction**

Gas burner components are usually made of cast metal, as they must take high temperatures, be very robust and withstand corrosion. Many parts can be made from aluminium, except for those parts which might reach temperatures above its softening point ( $600^\circ\text{C}$ ). Cast iron is used for parts that reach higher temperatures, as it is fairly resistant to corrosion. However, it is brittle and can shatter if dropped onto a hard surface. Mild steel can take high temperatures, is not brittle, is easily welded and is very strong, so can be used for many components. However steel is susceptible to corrosion, so must be coated with a corrosion inhibitor that can withstand the temperature in which the steel is being used. There are aluminium based paints that are designed for high temperature use, as well as vitreous enamels that are baked onto the metal surface.

Gas burner parts can also be made from ceramics, which are much cheaper than metals, easy to mould and can be baked in a furnace to give a hard material that can withstand high temperatures and is not susceptible to corrosion. The main disadvantage is that they are brittle and can shatter if dropped on a hard surface. Biogas burners have been made almost entirely from ceramic, apart from the orifice and injector tube.

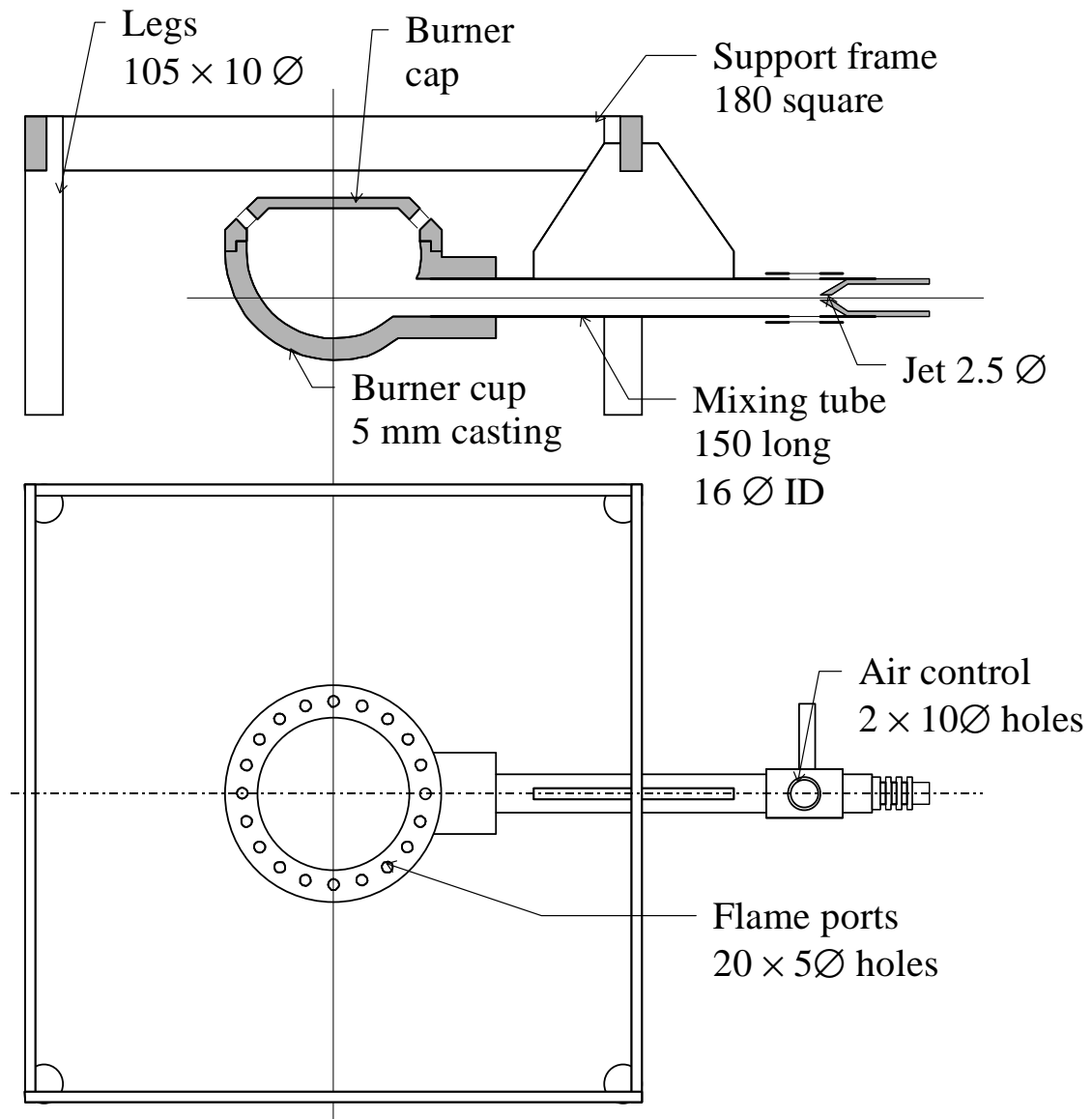

DCS burner, as used in Nepal

One or two supplied with each biogas plant. Manufactured at about 3000 plants per year.

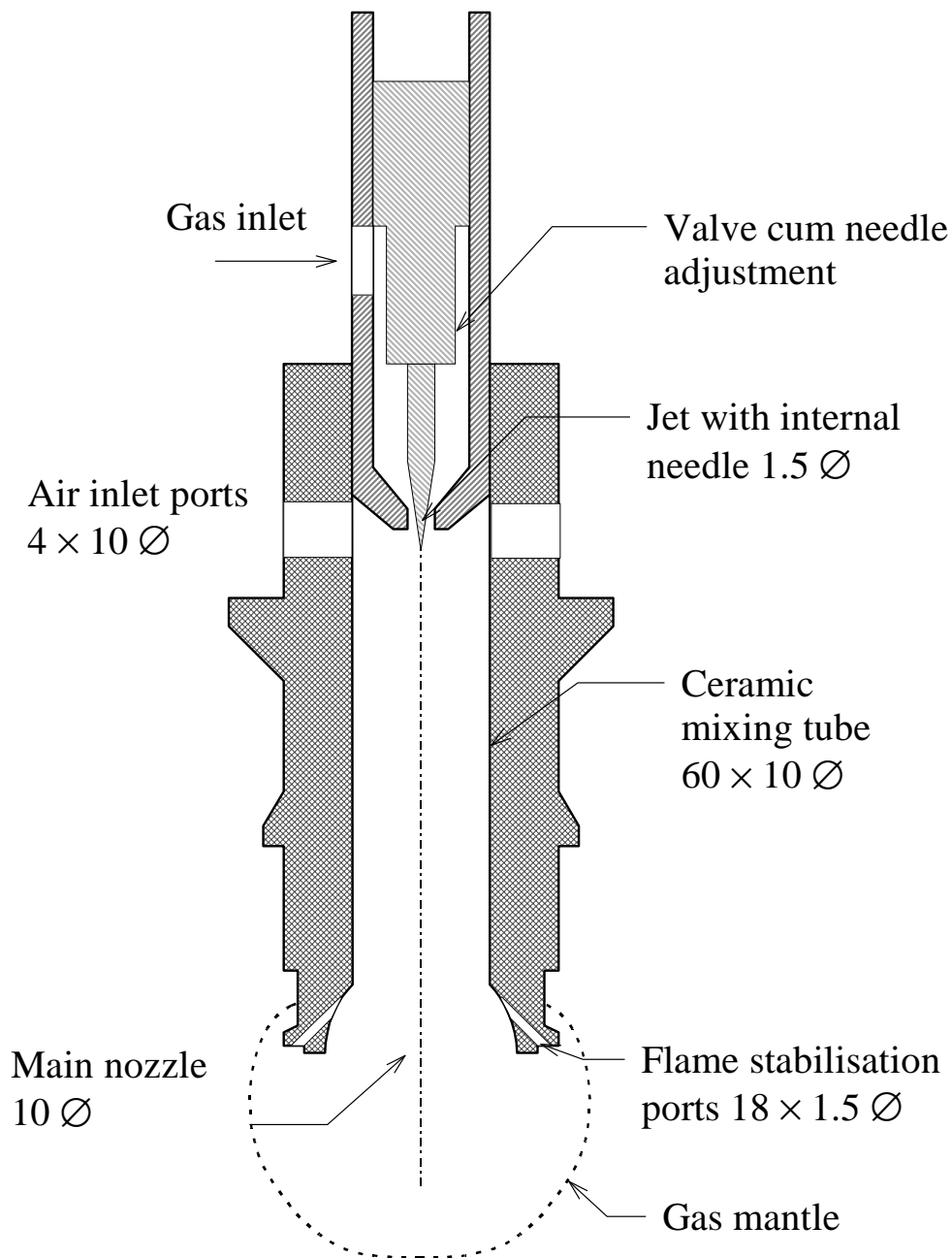

### DCS gas lamp burner design

The mantle is made of silk dipped in a mixture of rare earth salts (thorium and cerium). Once the silk has burnt away, these salts glow strongly when heated. The flame temperature can be adjusted using the needle in the jet.