

Agrodok 43

**Rainwater harvesting
for domestic use**

Janette Worm
Tim van Hattum

This publication is sponsored by: ICCO and AIDEnvironment

© Agromisa Foundation and CTA, Wageningen, 2006.

All rights reserved. No part of this book may be reproduced in any form, by print, photocopy, microfilm or any other means, without written permission from the publisher.

First edition: 2006

Authors: Janette Worm, Tim van Hattum
Illustrators: Liesbeth Worm, Barbera Oranje
Design: Eva Kok
Translation: Catherina de Kat-Reynen (editing)
Printed by: Digigrafi, Wageningen, the Netherlands

ISBN Agromisa: 90-8573-053-8
ISBN CTA: 92-9081-330-X

Foreword

The publishers and the Rainwater harvesting Implementation Network (RAIN) are pleased to present this long-awaited Agrodok on rainwater harvesting (RWH) for domestic use that supplements Agrodok No. 13 on RWH for agricultural purposes.

This booklet explains how to collect, store and purify rainwater for direct use at household level. It is a practical guide to creating a rainwater harvesting infrastructure from design to implementation that is illustrated with pictures, tables and examples from RAIN's experience. However, it is by no means comprehensive, since there are numerous specialised RWH techniques determined by local circumstances such as rainfall, culture, materials and costs.

We hope this Agrodok will be helpful to households as well as to community-based organisations, NGOs, local government staff and extension workers in both rural and urban areas.

Agromisa is grateful to ICCO and AIDEnvironment who made it possible to publish this Agrodok.

We would like to thank Jo Smet (IRC), Willem Boelhouwer (IRCSA) and Joep Blom (Practica Foundation) for their valuable comments on the draft document. Our thanks also go to Liesbeth Worm and Barbera Oranje, who kindly provided illustrations.

Janette Worm and Tim van Hattum

Contents

1	Introduction	6
2	Need for rainwater harvesting	8
2.1	Reasons for rainwater harvesting	9
2.2	Advantages and disadvantages	10
3	Basic principles of rainwater harvesting	12
3.1	Definition	12
3.2	Catchment surface	13
3.3	Delivery system	13
3.4	Storage reservoirs	15
4	Pre-conditions for rainwater harvesting	18
4.1	Environmental considerations	18
4.2	Technical aspects	19
4.3	Water consumption and water management	20
4.4	Social and gender aspects	21
4.5	Financial aspects	23
4.6	Is rainwater harvesting suitable for me?	24
5	Designing a rainwater harvesting system	27
5.1	Step 1: Total amount of required and available rainwater	27
5.2	Step 2: Designing your catchment area	30
5.3	Step 3: Designing your delivery system	31
5.4	Step 4: Sizing your storage reservoir	35
5.5	Step 5: Selection of a suitable storage reservoir design	40
6	Materials, construction and costs of storage reservoirs	41
6.1	Selecting the most appropriate storage reservoir	42
6.2	Available materials and costs	44
6.3	Water extraction devices and tank overflow	45

6.4	Description and examples of some rainwater reservoir designs	47
7	Water quality aspects	58
7.1	Protecting water quality	58
7.2	Filters	60
7.3	First-flush	61
7.4	Treatment of stored water	63
8	Usage and maintenance	66
8.1	Regular maintenance	67
8.2	Infrequent and annual tasks	68
	Appendix 1: Checklist for construction of storage reservoirs	69
	Appendix 2: About RAIN	74
	Further reading	76
	Useful addresses	78
	Glossary	82

1 Introduction

Millions of people throughout the world do not have access to clean water for domestic purposes. In many parts of the world conventional piped water is either absent, unreliable or too expensive. One of the biggest challenges of the 21st century is to overcome the growing water shortage. Rainwater harvesting (RWH) has thus regained its importance as a valuable alternative or supplementary water resource, along with more conventional water supply technologies. Much actual or potential water shortages can be relieved if rainwater harvesting is practised more widely.

People collect and store rainwater in buckets, tanks, ponds and wells. This is commonly referred to as rainwater harvesting and has been practised for centuries. Rainwater can be used for multiple purposes ranging from irrigating crops to washing, cooking and drinking.

Rainwater harvesting is a simple low-cost technique that requires minimum specific expertise or knowledge and offers many benefits. Collected rainwater can supplement other water sources when they become scarce or are of low quality like brackish groundwater or polluted surface water in the rainy season. It also provides a good alternative and replacement in times of drought or when the water table drops and wells go dry. One should, however, realise that rainfall itself cannot be managed. Particularly in arid or semi-arid areas, the prevailing climatic conditions make it of crucial importance to use the limited amount of rainfall as efficiently as possible. The collected rainwater is a valuable supplement that would otherwise be lost by surface run-off or evaporation.

During the past decade, RWH has been actively reintroduced by local organisations as an option for increasing access to water in currently underserved areas (rural or urban). Unfortunately decision-makers, planners, engineers and builders often overlook this action. The reason that RWH is rarely considered is often simply due to lack of informa-

tion on feasibility both technical and otherwise. During the past decade the technology has, however, quickly regained popularity as users realise the benefits of a relatively clean, reliable and affordable water source at home.

In many areas RWH has now been introduced as part of an integrated water supply, where the town water supply is unreliable, or where local water sources dry up for a part of the year. But RWH can also be introduced as the sole water source for communities or households. The technology is flexible and adaptable to a very wide variety of conditions. It is used in the richest and the poorest societies, as well as in the wettest and the driest regions on our planet.

This Agrodok discusses the potential of rainwater for local communities at household and community level. It strives to give practical guidance for households, CBOs, NGOs, local government staff and extension workers in designing and applying the right systems, methods and techniques for harvesting rainwater on a small scale (varying from 500 – 60,000 litres). It explains the principles and components of a rooftop rainwater system for collecting and storing rainwater. It also strives to guide the process of planning, designing and actual construction.

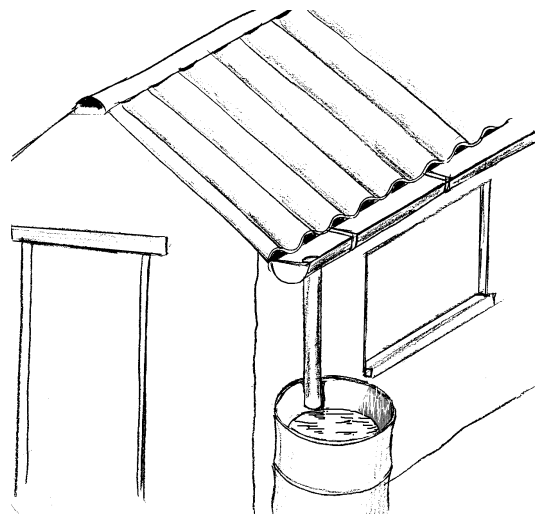

Figure 1: Rainwater harvesting system

2 Need for rainwater harvesting

Due to pollution of both groundwater and surface waters, and the overall increased demand for water resources due to population growth, many communities all over the world are approaching the limits of their traditional water resources. Therefore they have to turn to alternative or 'new' resources like rainwater harvesting (RWH). Rainwater harvesting has regained importance as a valuable alternative or supplementary water resource. Utilisation of rainwater is now an option along with more 'conventional' water supply technologies, particularly in rural areas, but increasingly in urban areas as well. RWH has proven to be of great value for arid and semi-arid countries or regions, small coral and volcanic islands, and remote and scattered human settlements.



Figure 2: Storage of rainwater

Rainwater harvesting has been used for ages and examples can be found in all the great civilisations throughout history. The technology can be very simple or complex depending on the specific local circumstances. Traditionally, in Uganda and in Sri Lanka rainwater is collected from trees, using banana leaves or stems as gutters; up to 200 litres may be collected from a large tree in a single rain storm. With the increasing availability of corrugated iron roofing in many developing countries, people often place a small container under their eaves to collect rainwater. One 20-litre container of clean water captured from the roof can save a walk of many kilometres to the nearest clean water source. Besides small containers, larger sub-surface and surface tanks are used for collecting larger amounts of rainwater.

Many individuals and groups have taken the initiative and developed a wide variety of different RWH systems throughout the world.

2.1 Reasons for rainwater harvesting

The reasons for collecting and using rainwater for domestic use are plentiful and varied:

1 Increasing water needs/demands

The increased need for water results in lower groundwater tables and depleted reservoirs. Many piped water supply systems fail. The use of rainwater is a useful alternative.

2 Variations in water availability

The availability of water from sources such as lakes, rivers and shallow groundwater can fluctuate strongly. Collecting and storing rainwater can provide water for domestic use in periods of water shortage. Rainwater may also provide a solution when the water quality is low or varies during the rainy season in rivers and other surface water resources (for example in Bangladesh).

3 Advantage of collection and storage near the place of use

Traditional sources are located at some distance from the community. Collecting and storing water close to households improves the accessibility and convenience of water supplies and has a positive impact on health. It can also strengthen a sense of ownership.

4 Quality of water supplies

Water supplies can become polluted either through industrial or human wastes or by intrusion of minerals such as arsenic, salt (coastal area) or fluoride. Rainwater is generally of good quality.

2.2 Advantages and disadvantages

When considering the possibility of using rainwater catchment systems for domestic supply, it is important to consider both the advantages and disadvantages and to compare these with other available options. RWH is a popular household option as the water source is close by, convenient and requires a minimum of energy to collect. An advantage for household systems is that users themselves maintain and control their systems without the need to rely on other members of the community. Since almost all roofing material is acceptable for collecting water for household purposes, worldwide many RWH systems have been implemented successfully.

However, RWH has some disadvantages. The main disadvantage of RWH is that one can never be sure how much rain will fall. Other disadvantages, like the relatively high investment costs and the importance of maintenance, can largely be overcome through proper design, ownership and by using as much locally available material as possible to ensure sustainability (and cost recovery). The involvement of the local private sector and local authorities can facilitate upscaling of RWH. Some advantages and disadvantages are given in Table 1.

Table 1: Advantages and disadvantages of rainwater harvesting

Advantages	Disadvantages
Simple construction: Construction of RWH systems is simple and local people can easily be trained to build these themselves. This reduces costs and encourages more participation, ownership and sustainability at community level.	High investment costs: The cost of rainwater catchment systems is almost fully incurred during initial construction. Costs can be reduced by simple construction and the use of local materials.
Good Maintenance: Operation and maintenance of a household catchment system are controlled solely by the tank owner's family. As such, this is a good alternative to poor maintenance and monitoring of a centralised piped water supply.	Usage and maintenance: Proper operation and regular maintenance is a very important factor that is often neglected. Regular inspection, cleaning, and occasional repairs are essential for the success of a system.
Relatively good water quality: Rainwater is better than other available or traditional sources (groundwater may be unusable due to fluoride, salinity or arsenic).	Water quality is vulnerable: Rainwater quality may be affected by air pollution, animal or bird droppings, insects, dirt and organic matter.
Low environmental impact: Rainwater is a renewable resource and no damage is done to the environment.	Supply is sensitive to droughts: Occurrence of long dry spells and droughts can cause water supply problems.
Convenience at household level: It provides water at the point of consumption.	Limited supply: The supply is limited by the amount of rainfall and the size of the catchment area and storage reservoir.
Not affected by local geology or topography: Rainwater collection always provides an alternative wherever rain falls.	
Flexibility and adaptability of systems to suit local circumstances and budgets, including the increased availability of low-cost tanks (e.g. made of Ferro cement, plastics or stone/bricks).	

3 Basic principles of rainwater harvesting

3.1 Definition

Water harvesting in its broadest sense can be defined as the collection of run-off rainwater for domestic water supply, agriculture and environmental management. Water harvesting systems, which harvest run-off from roofs or ground surfaces fall under the term rainwater harvesting. This Agrodok focuses on rainwater harvesting from roof surfaces at household or community level for domestic purposes, such as drinking, cooking and washing.

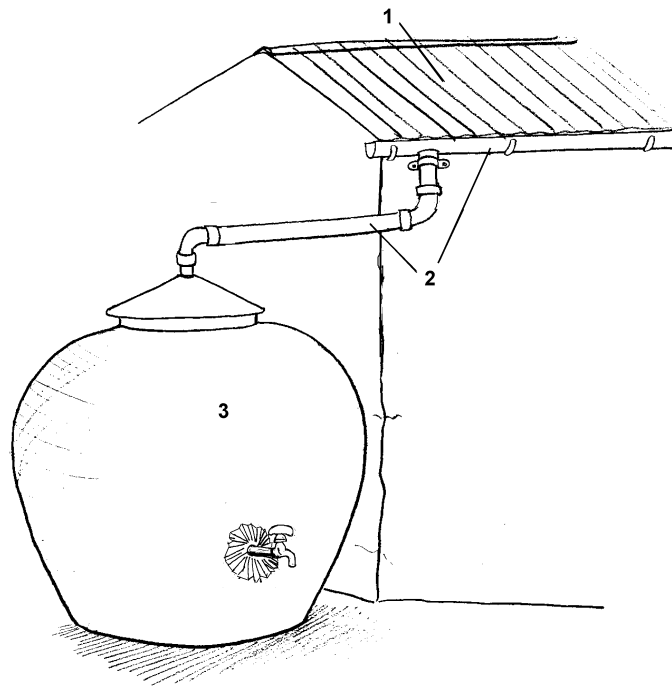

Figure 3: Three basic components of a rainwater harvesting system: catchment (1), delivery system (2), storage reservoir (3)

Each rainwater harvesting system consists of three basic components (Figure 3):

- 1 catchment or roof surface to collect rainwater
- 2 delivery system to transport the water from the roof to the storage reservoir (gutters and drainpipes)
- 3 storage reservoir or tank to store the water until it is used. The storage reservoir has an extraction device that- depending on the location of the tank- may be a tap, rope and bucket, or a pump.

3.2 Catchment surface

The catchment of a water harvesting system is the surface that receives rainfall directly and drains the water to the system. This Agrodok focuses on rooftop RWH, but surface run-off RWH is also possible. Surface water is, however, in most cases not suitable for drinking purposes since the water quality is not good enough.

Any roofing material is acceptable for collecting water. However, water to be used for drinking should not be collected from thatched roofs or roofs covered with asphalt. Also lead should not be used in these systems. Galvanised, corrugated iron sheets, corrugated plastic and tiles make good roof catchment surfaces. Flat cement or felt-covered roof can also be used provided they are clean. Undamaged asbestos-cement sheets do not have a negative effect on the water quality. Small damages may, however, cause health problems!

3.3 Delivery system

The delivery system from the rooftop catchment usually consists of gutters hanging from the sides of the roof sloping towards a downpipe and tank. This delivery system or guttering is used to transport the rainwater from the roof to the storage reservoir. For the effective operation of a rainwater harvesting system, a well-designed and carefully constructed gutter system is crucial because the guttering is often the weakest link in a rainwater harvesting system. As much as 90% or more of the rainwater collected on the roof will be drained to the stor-

age tank if the gutter and downpipe system is properly fitted and maintained. Common material for gutters and downpipes are metal and PVC. With high intensity rains in the tropics, rainwater may shoot over the (conventional) gutter, resulting in rainwater loss and low harvesting production; splash guards can prevent this spillage.



Figure 4: Connecting a gutter system

3.4 Storage reservoirs

The water storage tank usually represents the biggest capital investment element of a domestic RWH system. It therefore usually requires the most careful design – to provide optimal storage capacity and structural strength while keeping the costs as low as possible. Common vessels used for very small-scale water storage in developing countries include plastic bowls and buckets, jerry cans, clay or ceramic jars, old oil drums or empty food containers.

For storing larger quantities of water the system will usually require a tank above or below the ground. Tanks can vary in size from a cubic metre (1,000 litres) up to hundreds of cubic metres for large reservoirs. In general the size varies from 10 up to a maximum of 30 cubic metres for a domestic system at household level and 50 to 100 cubic metres for a system at community or school level, of course very much dependent on the local rain pattern throughout the year. Round shaped tanks are generally stronger than square-shaped tanks. Furthermore, round-shaped tanks require less material compared to the water storage capacity of square tanks.

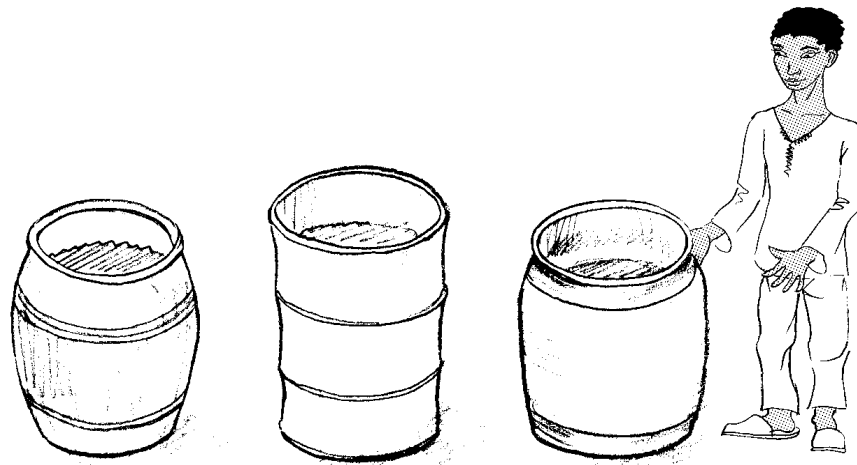

Figure 5: Vessels used for small-scale water storage

There are two categories of storage reservoirs: surface tanks and sub-surface tanks. Surface tanks are most common for roof collection. Materials for surface tanks include metal, wood, plastic, fibreglass, brick, inter-locking blocks, compressed soil or rubble-stone blocks, ferro cement and reinforced concrete. The choice of material depends on local availability and affordability. In most countries, plastic tanks in various volumes are commonly available on the market. Surface tanks are generally more expensive than underground tanks, but also more durable. A tap is required to extract the water from the surface tank.

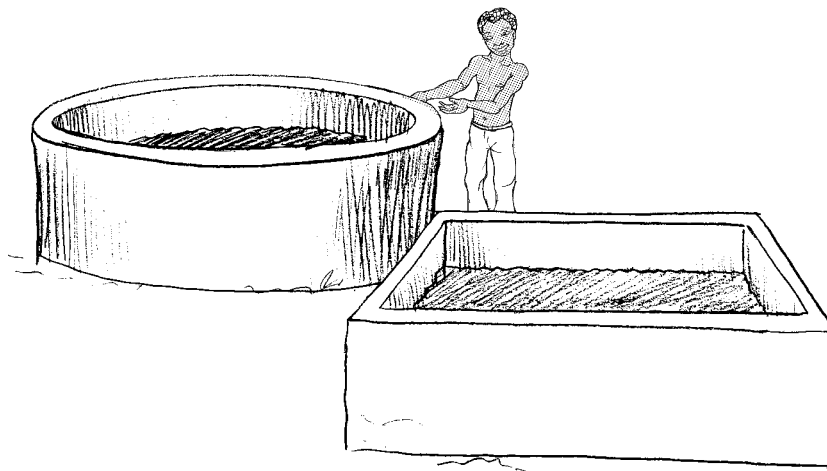

Figure 6: Storage reservoirs for large quantities of water (from 1 m³ to 30 m³ for a domestic system at household level)

The material and design for the walls of sub-surface tanks or cisterns must be able to resist the soil and soil water pressures from outside when the tank is empty. Tree roots can damage the structure below ground. Careful location of the tank is therefore important. Keeping it partly above the ground level and largely above the groundwater table will prevent problems with rising groundwater tables and passing trucks, which may damage the construction below the surface. Local materials such as wood, bamboo and basket work can be used as al-

alternatives to steel for reinforcing concrete tanks. A sub-surface tank or cistern requires a water-lifting device, such as a pump or bucket-rope system. To prevent contamination of the stored water, a safe water-lifting device and regular maintenance and cleaning are important.

4 Pre-conditions for rainwater harvesting

Many individuals and local communities throughout the world have developed a variety of RWH systems. A number of factors in addition to cost should be considered when choosing appropriate water sources or a specific rainwater harvesting system. Climate (rainfall pattern and rain intensity), technology, socio-economical factors, local livelihood, political system, and organisational management all play an important role in the eventual choice. An essential starting point when considering a rainwater catchment system for domestic water supply is to determine its environmental, technological and socio-economic feasibility. This chapter describes these important aspects of choosing the right system.

4.1 Environmental considerations

Environmental feasibility depends on the amount and patterns of rainfall in the area, the duration of dry periods and the availability of other water sources. The rainfall pattern over the year plays a key role in determining whether RWH can compete with other water supply systems. Tropical climates with short (one to four month) dry seasons and multiple high-intensity rainstorms provide the most suitable conditions for water harvesting. In addition, rainwater harvesting may also be valuable in wet tropical climates (e.g. Bangladesh), where the water quality of surface water may vary greatly throughout the year. As a general rule, rainfall should be over 50 mm/month for at least half a year or 300 mm/year (unless other sources are extremely scarce) to make RWH environmentally feasible. In table 2 some examples are given for annual rainfall in different regions.

Table 2: Average annual rainfall in different regions

Region	Annual rainfall	Examples
Desert	0-100 mm	Sahara
Semi-desert	100-250 mm	Senegal
Arid	250-500 mm	Ethiopia, Senegal
Semi-arid	500-750 mm	Gujurat India, Ethiopia
Semi-humid	900-1500 mm	Nepal, India
Wet Tropics	Over 2000 mm	Bangladesh

4.2 Technical aspects

The construction of a RWH system is determined by several critical technical factors:

- use of impermeable roofing material such as iron sheets, tiles, asbestos-cement
- availability of an area of at least 1 m² near each house for constructing a storage tank
- water consumption rate (number of users and types of uses) and storage capacity required
- availability of other water sources, either ground water or surface water that can be used when stored rainwater runs out
- availability of labourers with technical building skills in or nearby the community
- availability of required, suitable local construction material and labour

In some parts of the world RWH is only used to collect enough water during a storm to save a trip or two to the main water source (open well or pump). In this case only a small storage container is required and people use it exclusively for drinking water (e.g. Thailand). In arid areas, however, people strive to create sufficient catchment surface area and storage capacity to provide enough water to meet all the needs of the users.

Four types of user regimes can be discerned:

- Occasional - Water is stored for only a few days in a small container. This is suitable when there is a uniform rainfall pattern and very few days without rain and there is a reliable alternative water source nearby.
- Intermittent – There is one long rainy season when all water demands are met by rainwater, however, during the dry season water is collected from non-rainwater sources. RWH can then be used to bridge the dry period with the stored water when other sources are dry.
- Partial - Rainwater is used throughout the year but the ‘harvest’ is not sufficient for all domestic demands. For instance, rainwater is used for drinking and cooking, while for other domestic uses (e.g. bathing and laundry) water from other sources is used.
- Full – Only rainwater is used throughout the year for all domestic purposes. In such cases, there is usually no alternative water source other than rainwater, and the available water should be well managed, with enough storage capacity to bridge the dry period.

The availability and affordability (costs) of material is one of the critical technical considerations. The following lists the most preferred types of the materials that are necessary for constructing a RWH structure.

- Roofing: galvanised, corrugated iron sheets, corrugated plastic or tiles
- Gutters made of local materials (e.g. metal, aluminium, ceramic, bamboo, PVC)
- Storage tank: bricks made with cement mortar or plain cement concrete or reinforced cement concrete, including steel bars or wire and the required shuttering (planks or galvanised sheets) for pouring the cement
- Downpipe made of local materials (e.g. metal, aluminium, ceramic, PVC)
- Tapping device

4.3 Water consumption and water management

Where water is very scarce, people may use as little as 3 to 4 litres per person per day for drinking only, while about 15-25 litres per person

will be sufficient for drinking, cooking and personal hygiene. These quantities vary per country, community, and household, and also vary over time as consumption rates may change in different seasons. Socio-economic conditions and different uses of domestic water are also influencing factors. Estimating household water demand must thus be done with care and in close consultation with the local stakeholders. In general, rooftop rainwater harvesting can only provide sufficient water for a small vegetable plot unless there is a high amount of rainfall or it is collected in a large reservoir.



Figure 7: Water for basic hygiene

Management of water at household and community level remains important. Particularly during the dry season or when water levels are low, the allocation or use of the remaining water should be restricted.

4.4 Social and gender aspects

The following social aspects should be considered when designing a household-based or community-based system:

- There should be a real felt need in the family or community for better water provision.
- The design should be affordable and cost-effective.
- The family or community should be enthusiastic and fully involved.
- Examples of positive experiences with previous projects should be available.
- Social cohesion is essential.

As with the introduction of any new technology, social and economic considerations are important for ensuring the local appropriateness and the sustainability of the rainwater harvesting structure in terms of wage and maintenance. The local circumstances, including stakeholders such as NGOs, district planners, health workers, village water committees, the village government, the private sector (materials suppliers, contractors, plumbers, etc.) and end-users of the provided water, should be considered right from the start when planning and designing any RWH system. The different roles of women and men (i.e. the gender perspective) should be considered with particular care with respect to planning, designing and using a RWH system. One should recognise which group can do what best, and ensure that both groups have a clear role. Leave it up to the local community to decide what each gender group should do.

Ownership by both women and men is very important. Women are often the main end-users of domestic water at household or community level. They are responsible for providing the food and drinking water, taking care of the vegetable garden, doing the washing and for the hygiene of the children. However, cultural and societal practices often exclude women from actually designing and building RWH structures. Typically, men plan and design RWH structures without properly consulting women. Empowering women in RWH planning and building is important as it will make them more visible, allow them to articulate their ideas and use their knowledge for designing and implementing the RWH structures. This in turn will ensure the sustainability of the system.

The most fruitful approach for introducing gender equality and empowering women appears to be one in which all partners – men and women – communicate, organise, manage, operate, maintain and monitor a RWH system. Just involving more women is not sufficient as women's rights and inputs may still be ignored, particularly in relation to the decision-making process. Not only are their increased consultation and participation throughout the planning phase crucial; their

continued involvement in the project is also important to ensure an appropriate and functional system.

Another important reason for consulting local stakeholders and beneficiaries (men and women) is that they may provide the required labour and materials and can provide a community perspective and help each other in raising funds for construction. The construction of a RWH system may as such have a positive effect on the local economy because all money paid for labour or materials tends to stay in the community.



Figure 8: Women carrying water

4.5 Financial aspects

Besides social and gender aspects, the financial circumstances may also influence the design of a RWH structure. However, one should realise that financial reasons can hardly be a restriction for building a rainwater catchment system. Run-off from a roof can be directed with little more than a split pipe or piece of bamboo into an old oil drum (provided that it is clean) placed near the roof. More advanced de-

signs include the use of aluminium pipes and a reinforced cement tank with a first-flush, overflow tap and a water quality filter. Between those extremes there are many different suitable options and techniques.

Almost every house or building has a suitable catchment area or roof, but the guttering and the water storage do require some investments. The water storage tank or reservoir usually represents the biggest capital investment element of a rainwater harvesting system and therefore requires careful design to provide optimal storage capacity while keeping the cost as low as possible.

Installing a water harvesting system at household level can cost anywhere from USD100 to 1,000. It is difficult to make an exact estimate of cost because it varies widely depending on the availability of existing structures, like rooftop surface, pipes and tanks and other materials that can be modified for a water harvesting structure. Additionally, the cost estimate mentioned above is for an existing building and the actual cost depends on the final design and size of the tank, and the availability and price of these items. The cost would be comparatively less if the system were incorporated during the construction of the building itself. Therefore rainwater harvesting is particularly recommended for reconstruction operations after natural disasters (such as the tsunami in Asia) or wars.

4.6 Is rainwater harvesting suitable for me?

In order to find out whether RWH is suitable for your particular situation several critical issues need to be considered. The design of a RWH system is determined by several factors:

- the number of users and their consumption rate (multiple uses)
- local rainfall data and rainfall pattern
- user regime of the system (occasional, intermittent, partial or full)
- roof catchment area (m²)
- run-off coefficient (this varies between 0.5 and 0.9 depending on roof material and slope)

First you need to determine the rainwater needs of your household. Usually this is based on the family size and the availability of alternative water resources. In addition you need to identify the multiple uses of water and the quantities needed per day for drinking, cooking, gardening, washing, etc. Together these uses and quantities determine the amount of water that your household needs. Secondly, you need to identify what the duration is of the dry period between the rains. Based on the duration of the dry period and the water needs of your household you can determine the capacity or size of the tank you need. Subsequently, the roof surface for collecting or harvesting rainwater, the locally available materials and the available budget will dictate the actual design and capacity of your tank that you can construct for your household. A checklist for the points that need to be considered when assessing the feasibility of a RWH system is given below:

<p>Checklist for assessing feasibility of RWH system</p> <p><i>Technical feasibility</i></p> <ul style="list-style-type: none"> ➤ Rainfall and catchment area must be sufficient to meet the demand. ➤ Design should be appropriate (e.g. easy to maintain). ➤ Materials should be available. ➤ Skills must be available locally. <p><i>Social and economic feasibility</i></p> <ul style="list-style-type: none"> ➤ There should be a real felt need for better water provision. ➤ Designs should be affordable and cost-effective. ➤ Community should be enthusiastic and fully involved. <p><i>Environmental feasibility and health</i></p> <ul style="list-style-type: none"> ➤ Rainwater harvesting should improve both the quantity and quality of the available water. ➤ It should have a positive impact on the users' health. <p><i>Alternatives</i></p> <ul style="list-style-type: none"> ➤ All reasonable alternative means of water provision should be investigated. ➤ Using other options in combination with rainwater supply should be considered.

Figure 9 illustrates what issues should be considered in designing your domestic rainwater harvesting structure.

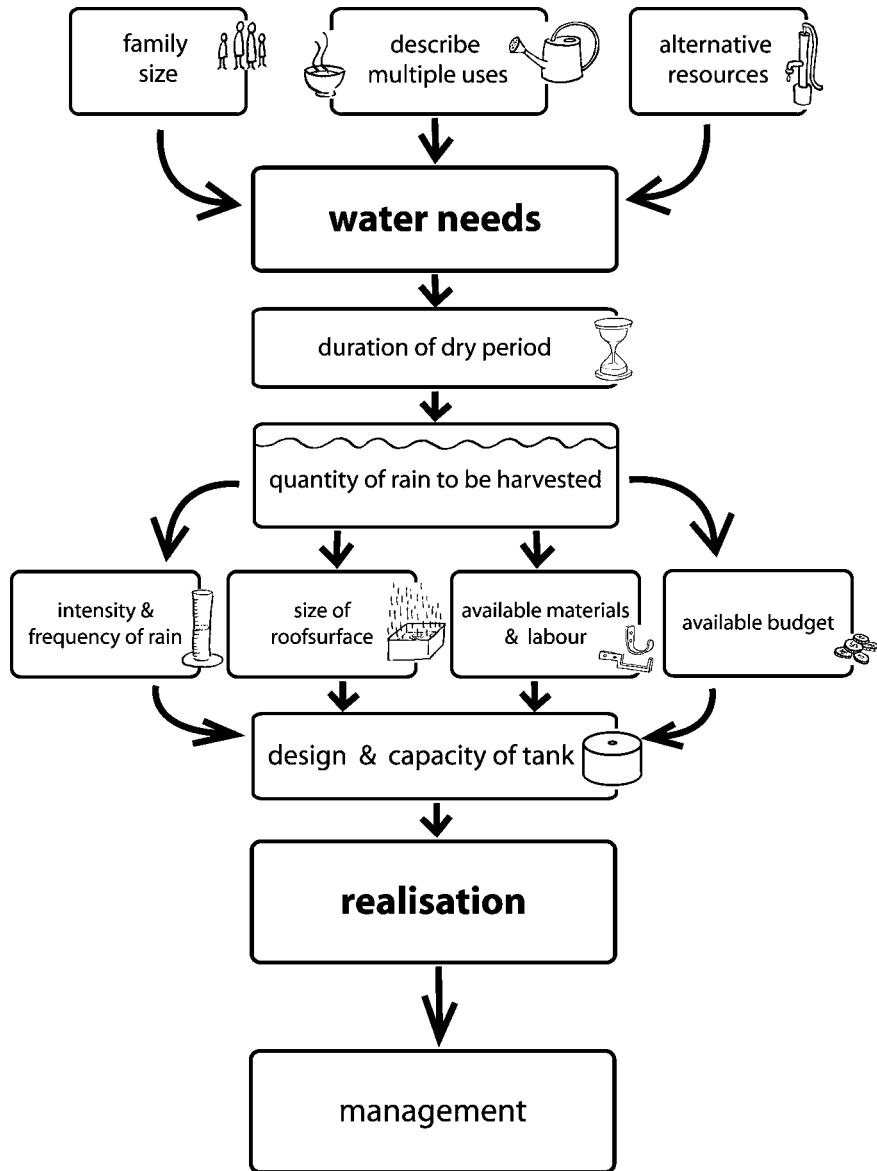

Figure 9: Issues to be considered in designing your RWH system

5 Designing a rainwater harvesting system

The main consideration in designing a rainwater harvesting system is to size the volume of the storage tank correctly. The tank should give adequate storage capacity at minimum construction costs.

Five steps to be followed in designing a RWH system:

Step 1 Determine the total amount of required and available rainwater

Step 2 Design your catchment area

Step 3 Design your delivery system

Step 4 Determine the necessary size of your storage reservoir

Step 5 Select suitable design of storage reservoir

These steps are described below.

5.1 Step 1: Total amount of required and available rainwater

Estimating domestic water demand

The first step in designing a rainwater harvesting system is to consider the annual household water demand. To estimate water demand the following equation can be used:

$$\text{Demand} = \text{Water Use} \times \text{Household Members} \times 365 \text{ days}$$

For example, the water demand of one household is 31,025 litres per year when the average water use per person is 17 litres per day and the household has 5 family members:

$$\text{Demand} = 17 \text{ litres} \times 5 \text{ members} \times 365 \text{ days} = 31,025 \text{ litres per year}$$

However, in reality it may not be so easy. Children and adults use different amounts of water and seasonal water use varies, with more water being used in the hottest or driest seasons. The number of household members staying at home may also vary at different times of the

year. By estimating the average daily water use these variables should be taken into account. Domestic water demand includes all water used in and around the home for the following essential purposes: drinking, food preparation and cooking, personal hygiene, toilet flushing (if used), washing clothes and cleaning, washing pots and pans, small vegetable gardens, and other economic and productive uses (the latter only when sufficient rainwater is available).

Rainfall data

The next step is to consider the total amount of available water, which is a product of the total annual rainfall and the roof or collection surface area. These determine the potential value for rainwater harvesting. Usually there is a loss caused mostly by evaporation (sunshine), leakage (roof surface), overflow (rainwater that splashes over the gutters) and transportation (guttering and pipes). The local climatic conditions are the starting point for any design.

Climatic conditions vary widely within countries and regions. The rainfall pattern or monthly distribution, as well as the total annual rainfall, often determine the feasibility of constructing a RWH system. In a climate with regular rainfall throughout the year the storage requirement is low and the system cost will be low. It is thus very important to have insight into local (site-specific) rainfall data. The more reliable and specific the rainfall data is, the better the design can be. In mountainous locations and locations where annual precipitation is less than 500 mm per year, rainfall is very variable. Data from a rain gauging station 20 km away may be misleading when applied to your system location.

Rainfall data can be obtained from a variety of sources. The primary source should be the national meteorological organisation in the country. In some countries, however, rainfall statistics are limited due to lack of resources. Local water departments or organisations, local hospitals, NGOs or schools may be possible sources of rainfall information.

Calculating potential rainwater supply by estimating run-off

The amount of available rainwater depends on the amount of rainfall, the area of the catchment, and its run-off coefficient. For a roof or sloping catchment it is the horizontal plan area which should be measured (figure 10).

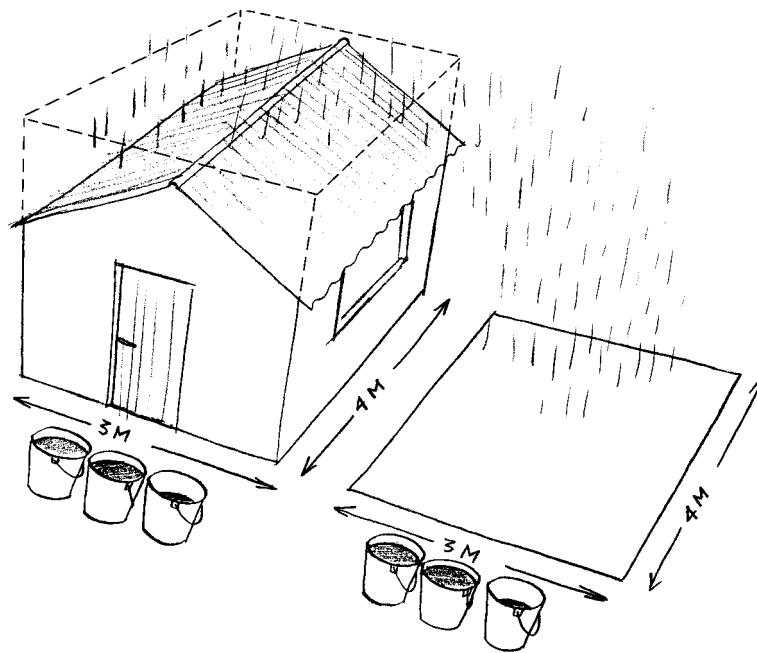

Figure 10: Horizontal plan area of the roof for calculating the catchment surface

The run-off coefficient (RC) takes into account any losses due to evaporation, leakage, overflow and transportation. For a well-constructed roof catchment system it is 0.9 (see section 5.2 below). An impermeable roof will yield a high run-off. An estimate of the approximate, mean annual run-off from a given catchment can be obtained using the following equation:

$$S = R \times A \times C_r$$

Supply = Rainfall \times Area \times Run-off coefficient (RC)

Where:

- S = Mean annual rainwater supply (m^3)
- R = Mean annual rainfall (m)
- A = Catchment area (m^2)
- C_r = Run-off coefficient

In the next example the mean annual rainfall is 500 mm/year (= 0.5 m/year) and the catchment area $3 \text{ m} \times 4 \text{ m} = 12 \text{ m}^2$:

$$S = 0.5 \text{ m/year} \times 12 \text{ m}^2 \times 0.9 = 5.4 \text{ m}^3 / \text{year} = 15 \text{ litres/ day}$$

5.2 Step 2: Designing your catchment area

Roofs provide an ideal catchment surface for harvesting rainwater, provided they are clean. The roof surface may consist of many different materials. Galvanised corrugated iron sheets, corrugated plastic and tiles all make good roof catchment surfaces. Flat cement roofs can also be used. Traditional roofing materials such as grass or palm thatch may also be used. If a house or a building with an impermeable (resistant to rain) roof is already in place, the catchment area is available free of charge.

The roof size of a house or building determines the catchment area and run-off of rainwater. The collection of water is usually represented by a run-off coefficient (RC). The run-off coefficient for any catchment is the ratio of the volume of water that runs off a surface to the volume of rainfall that falls on the surface. A run-off coefficient of 0.9 means that 90% of the rainfall will be collected. So, the higher the run-off coefficient, the more rain will be collected. An impermeable roof will yield a high run-off of good quality water that can be used for all domestic purposes: cooking, washing, drinking, etc. Thatched roofs can make good catchments, although run-off is low and the quality of the collected water is generally not good.

Table 3: Run-off coefficients for traditional roofing materials

Type	Run-off coefficient
Galvanised iron sheets	>0.9
Tiles (glazed)	0.6-0.9
Aluminium sheets	0.8-0.9
Flat cement roof	0.6-0.7
Organic (e.g. thatched)	0.2

Since roofs are designed to shed water, they have a high run-off coefficient and thus allow for quick run-off of rainwater. The roof material does not only determine the run-off coefficient, it also influences the water quality of the harvested rainwater. Painted roofs can be used for rainwater collection but it is important that the paint be non-toxic and not cause water pollution. For the same reason, lead flashing should also not be used for rainwater collection. There is no evidence that the use of asbestos fibre-cement roofs for rainwater collection poses any health risks due to water pollution. During construction or demolition of the roof, harmful asbestos particles may enter the air, so the risk of respiratory uptake of harmful substances may exist. Therefore, it is not recommended.

Thatched roofs can make good catchments, when certain palms are tightly thatched. Most palms and almost all grasses, however, are not suitable for high-quality rainwater collection. Grass-thatched catchments should be used only when no other alternatives are available. Then, tightly bound grass bundles are the best. Ideally, thatched roofs are not used for the collection of drinking water for reasons of organic decomposition during storage. Mud roofs are generally not suitable as a catchment surface.

5.3 Step 3: Designing your delivery system

The collected water from a roof needs to be transported to the storage reservoir or tank through a system of gutters and pipes, the so-called delivery system or guttering. Several other types of delivery systems exist but gutters are by far the most common. Commonly used materi-

als for gutters and downpipes are galvanised metal and plastic (PVC) pipes, which are readily available in local shops. There is a wide variety of guttering available from prefabricated plastics to simple gutters made on-site from sheet metal. In some countries bamboo, wood stems and banana leaves have been used. Gutters made from extruded plastic are durable but expensive. For the guttering, aluminium or galvanised metals are recommended because of their strength, while plastic gutters may suffice beneath small roof areas. Almost all plastics, certainly PVC, must be protected from direct sunlight. Generally, the cost of gutters is low compared to that of storage reservoirs or tanks, which tend to make up the greatest portion of the total cost of a RWH system.

Gutters are readily available in different shapes (Figure 11); they can be rounded, square, V-shaped, and have open or closed ends with attached downpipe connectors. They can be made in small workshops in sections that are later joined together or they can even be made on-site by plumbers. Workshop-made gutters usually have a square shape and tend to be two to three times more expensive than similar gutters made on-site. On-site gutters are usually V-shaped. These are quite efficient but they tend to get more easily blocked with debris and leaves. V-shaped gutters are usually tied directly under the roof or onto a so-called splash guard. V-shape gutters often continue all the way to the tank without addition of the usual rounded downpipe section.

Wooden planks and bamboo gutters are usually cheap (or even free of charge). These gutters do, however, suffer from problems of durability as the organic material will eventually rot away and leak. Their porous surfaces also form an ideal environment for accumulation of bacteria that may be subsequently washed into the storage tank.

Aluminium is naturally resistant to corrosion, which makes it last indefinitely. The cost of an aluminium sheet is over 1.5 times the cost of steel of the same thickness and the material is less stiff so for a similar strength of gutter a larger thickness of material is required, resulting in gutters that are up to three times more expensive. Nevertheless, there

is a growing market for aluminium sheets in developing countries so the price will almost certainly come down over time. Half pipes have been proposed as an inexpensive form of guttering and are used in many areas. The production is relatively simple, and the semi-circular shape is extremely efficient for RWH. The cost of these gutters depends on the local cost of piping, which may be more expensive than an equivalent sheet metal gutter.

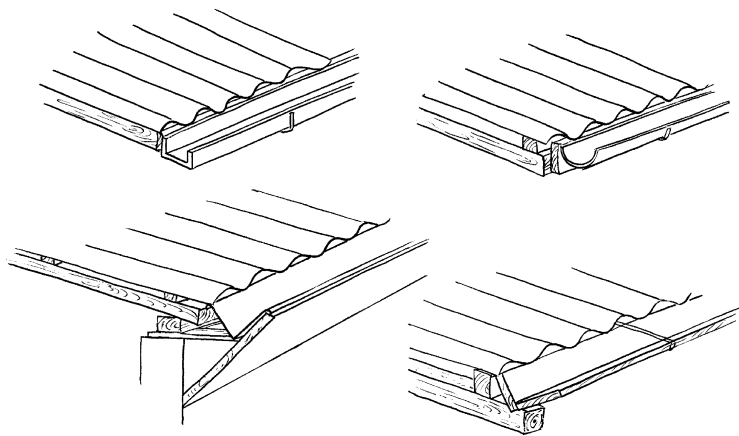

Figure 11: Different types of gutters: square, rounded, V-shaped

Proper construction of gutters is essential to avoid water losses (Figure 12). Gutters must slope evenly towards the tank to ensure a slow flow. Gutters are often the weak link in a RWH system and installations can be found with gutters leaking at joints or even sloping the wrong way.

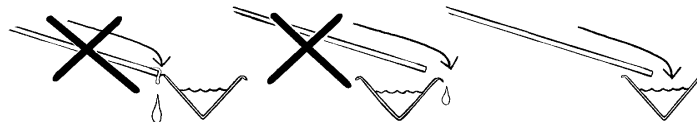

Figure 12: Proper construction of the gutter is important

Gutters must be properly sized and correctly connected around the whole roof area. When high intensity rainfall occurs, gutters need to be fitted with so-called splash guards to prevent overshooting water losses. A properly fitted and maintained gutter-downpipe system is capable of diverting more than 90% of all rainwater run-off into the storage tank. Although gutter size may reduce the overflow losses, additional splash guards should be incorporated on corrugated-iron roofs. Splash guards consist of a long strip of sheet metal 30 cm wide, bent at an angle and hung over the edge of the roof about 2-3 cm to ensure all run-off for the roof enters the gutter. The splash guard is connected to the roof and the lower half is hung vertically down from the edge of the roof.

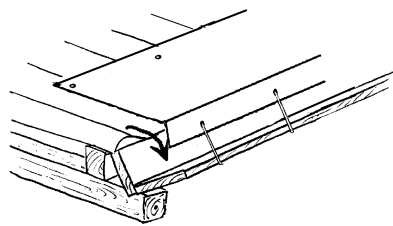

Figure 13: Splash guards

During intensive rainfall, large quantities of run-off can be lost due to gutter overflow and spillage if gutters are too small. To avoid overflow during heavy rains, it makes sense to create a greater gutter capacity. A useful rule of thumb is to make sure that there is at least 1 cm² of gutter cross-section for every 1 m² of roof surface. The usual 10 cm-wide rounded (e.g. 38 cm²) gutters are generally not big enough for roofs larger than about 40 m². A square-shaped gutter of 10 cm² can be used for roof areas measuring up to 100 m² under most rainfall regimes. For large roofs, such as on community buildings and schools, the 14 × 14 cm V-shaped design with a cross-sectional area of 98 cm² is suitable for roof sections up to 50 m long and 8 m wide (400 m²). When gutters are installed with a steeper gradient than 1:100 (1 cm vertical drop over 100 cm horizontal distance) and used together with splash guards, V-shaped gutters can cope with heavy rains without large amounts of loss. A gradient of 1:100 ensures steady water flow and less chance of gutter blockage from leaves or other debris. Down-pipes, which connect the gutters to the storage reservoir, should have similar dimensions to the gutters.

Important considerations for designing gutter/downpipe systems:

- The rule of thumb is 1 cm² gutter cross-section per 1 m² roof surface.
- Aluminium or galvanised metal are recommended for gutters because of their strength and resistance to sunlight.
- Gutters should slope towards the storage tanks. Increasing the slope from 1:100 to 3:100 increases the potential water flow by 10 – 20%.
- A well-designed gutter system can increase the longevity of a house. Foundations will retain their strength and the walls will stay dry.

The following tables give some examples of guttering systems. The guttering requirement for a typical household roof of 60 m² is shown in table 4. Typical gutter widths for such roofs are presented in table 5.

Table 4: Examples for guttering systems

Section	Roof size	Slope	Cross sectional area	Gutter sizes
Square	40-100 m ²	0.3-0.5%	70 cm ²	7 × 10 cm
Rounded	40-60 m ²	0.3-0.5%	63 cm ²	125 mm bore [?]
45° V-shaped	Not specified	1.0%	113 cm ²	15 cm on each side

Table 5: Gutter sizes quoted in literature

	Square 0.5% slope	Square 1.0% slope	Rounded 1.0% slope	45° V-shape 1.0% slope
Gutter width (at top)	71 mm	63 mm	96 mm	124 mm
Cross sectional area	47 cm ²	39 cm ²	36 cm ²	38 cm ²

5.4 Step 4: Sizing your storage reservoir

There are several methods for sizing storage reservoirs. These methods vary in complexity and sophistication. In this Agrodok two methods for inexperienced practitioners are explained:

- 1 Demand side approach (dry season demand versus supply)
- 2 Supply side approach (graphical methods)

The first method is the simplest method and most widely used. The second method uses statistical indicators of the average rainfall for a given place. If rainfall is limited and shows large fluctuations then a design based on only one single statistical indicator can be misleading.

Method 1: Demand side approach (dry season demand versus supply)

This is the simplest method to calculate the storage requirement based on the required water volume (consumption rates) and occupancy of the building. This approach is only relevant in areas with a distinct dry season. The tank is designed to meet the necessary water demand throughout the dry season. To obtain required storage volume the following equations can be used:

$$\text{Demand} = \text{Water Use} \times \text{Household Members} \times 365 \text{ days}$$

This equation provides the water demand in litres per year. Dividing by 12 months will give the required water demand in litres/month. The required monthly water demand multiplied by the dry period will give the required storage capacity.

$$\text{Required storage capacity} = \text{demand} \times \text{dry period}$$

As an example we can use the following typical data.

Assuming that:

- Water use (consumption per capita per day) = 20 litres
- Number of people in the household = 5
- Dry period (longest average dry period) = 4 months (120 days)
- Minimum storage capacity = T

Then: the water demand = $20 \text{ l} \times 5 \text{ persons} \times 365 \text{ days/year} = 36,500$ litres/year or about 3,000 l/month. For a dry period of four months, the required minimum storage capacity (T) is thus 12,000 litres ($T = 4 \times 3,000$); this calculation is however a rough estimate.

This simple method can be used in situations where there is sufficient rainfall and an adequate roof or catchment area. It is a method for calculating rough estimates of the required tank size and it does not take into account variations between different years, such as the occurrence of drought years. The method is easy to understand and is sufficient in many cases. It can be used in the absence of any rainfall data.

Method 2: Supply side approach (graphical methods)

Another method to estimate the most appropriate storage tank capacity for maximising supply is to represent roof run-off and daily consumption graphically. This method will give a reasonable estimation of the storage requirements. Daily or weekly rainfall data is required for a more accurate assessment. In low rainfall areas where rainfall has an uneven distribution there may be an excess of water during some months of the year, while at other times there will be a deficit. If there is sufficient water to meet the demand throughout the year, then sufficient storage will be required to bridge the periods of scarcity. As storage is expensive, this should be calculated carefully to avoid unnecessary expenses. This method will give an estimation of the storage requirements. There are three basic steps to be followed:

- 1 Plot a bar graph for mean monthly roof run-off for a specific house or building in a specific location. Add a line for the demand per month.
- 2 Plot a cumulative roof run-off graph, by summing the monthly run-off totals.
- 3 Add a dotted line showing cumulative water use (water withdrawn or water demand).

The example given is a spreadsheet calculation for a site in a semi-arid region with mean annual rainfall of 500 mm and a five-month dry season. Roof area is 100 m², run-off coefficient is 0.9. There are 5 household members and the average consumption is 20 litres per person per day. Water demand = 20 l × n × 365 days/year, where n= number of people in the household; if there are five people in the household then the annual water demand is 36,500 litres or about 3,000 l/month.

Water supply = roof area \times rainfall \times run-off coefficient = $100 \text{ m}^2 \times 500 \text{ mm} \times 0.9 = 45 \text{ m}^3$ or 45,000 litres per year or 123 litres per day. In order to meet the annual water demand 36,500 litres is necessary. The potential annual water supply cannot exceed 45,000 litres or 123 litres per day.

Figure 14 shows the amount of harvestable water (in bars) and the demand for each month (horizontal graph). The figure shows a single rainy season (from October to May). The first month when the collected rainfall (RWH) meets the demand is October. If it is assumed that the tank is empty at the end of September, a graph can be drawn to reflect the cumulative harvested water and cumulative demand. Based on this graph the maximum storage requirement can be calculated.

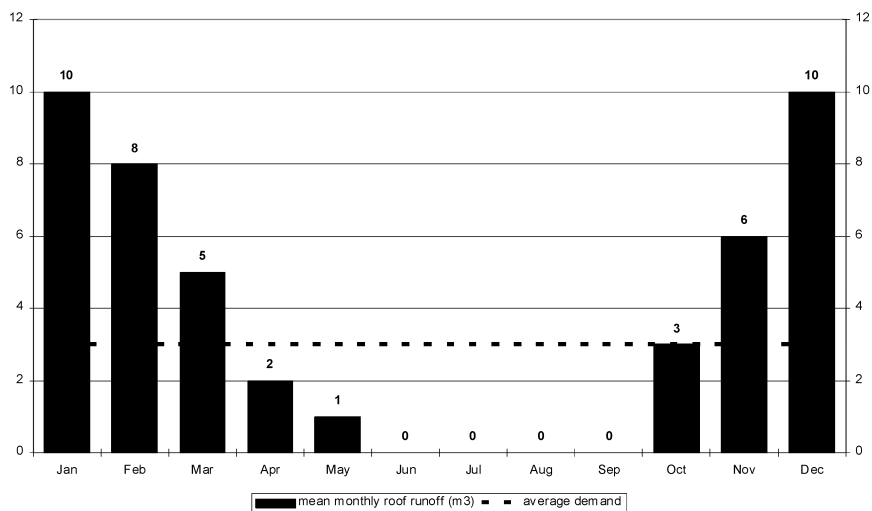

Figure 14: Mean monthly roof run-off and average demand

Figure 15 shows the cumulative monthly roof run-off. Total run-off in this case is 45 m^3 . A residual storage of 5 m^3 should be incorporated for the rainwater remaining in the tank at the start of the wet season. (See figure 16.)

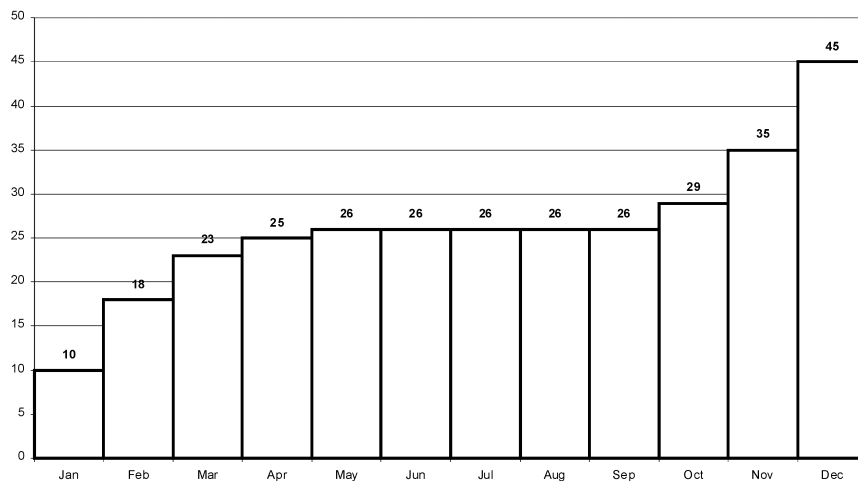

Figure 15: Cumulative monthly roof run-off

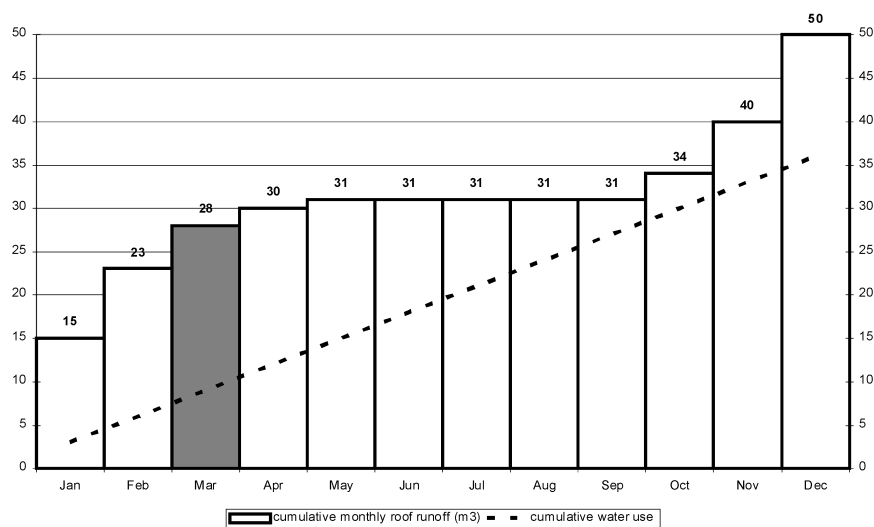

Figure 16: Cumulative monthly roof run-off including a residual storage of 5 m³ and cumulative water use. Estimation of storage requirement.

Figure 16 shows the spreadsheet calculation for sizing the storage tank. It takes into account the cumulative inflow and outflow from the tank, and the capacity of the tank is calculated as the greatest excess of water over and above consumption (greatest difference between the two lines). This occurs in March with a storage requirement of 20 cubic metres. All this water will have to be stored to cover the shortfall during the dry period.

5.5 Step 5: Selection of a suitable storage reservoir design

Suitable design of storage reservoirs depends on local conditions, available materials and budget, etc. In chapter 6, the materials, construction and costs of storage reservoirs are described in detail. This information is needed to select the most suitable design and realise the construction of the RWH system.

6 Materials, construction and costs of storage reservoirs

Storage reservoirs are usually the most expensive component in any roof catchment system and choosing the most appropriate type is important. The choice of tank will depend on the range and price of locally available commercial options and on the cost and availability of building materials. Some of the more common types of water tanks are described later in this chapter. This chapter contains an overview of all the factors involved in the construction of a RWH reservoir. In the following sections examples are given in a step-by-step approach of how these factors translate into practical situations. The following box summarises all steps for constructing a RWH reservoir.

General checklist for RWH reservoir construction

- 1 Contact local NGO with experience in RWH (see Useful Addresses).
- 2 Choose between a surface or sub-surface reservoir (see table 5).
- 3 Select materials and design (funds and material available).
- 4 Proper mixing of mortar and concrete is essential for good water tank construction.
- 5 Storage tank should be located close to supply and demand points to reduce the conveyance distance.
- 6 Solid foundation is essential for surface rainwater tanks, and a stable soil for sub-surface tanks.
- 7 If seasonal flooding is likely to occur, build the tank on higher ground to prevent flooding (and thus contamination) of the tank.
- 8 Protect the system from direct sunlight, mosquitoes and debris.
- 9 Tank inlet must be lower than the lowest point from the roof (catchment area).
- 10 Make sure the system is easily accessible for cleaning.
- 11 Make sure the system has sufficient structural strength.
- 12 Make sure the system is not hazardous to passers-by and children.
- 13 Include a drainage and overflow device to avoid damage to the foundation and other nearby structures.
- 14 Install a tapping device
- 15 Gutters and pipes must be properly constructed and slope evenly towards the tank.
- 16 Protect the water quality (see Chapter 7).
- 17 Ensure proper usage and maintenance (see Chapter 8).

6.1 Selecting the most appropriate storage reservoir

It is often best when constructing tanks to choose a design based on the use of local materials. This is usually the cheapest option. A tank is referred to as an above-ground storage reservoir and a cistern as a below-ground storage reservoir. Most storage tanks have a round or cylindrical shape, which is much stronger and uses less material than square or rectangular tanks. Both types of reservoirs (tank or cistern) can vary in size from a cubic metre or 1,000 litres up to hundreds of cubic metres for a tank at community level, but they typically range from 10 to 30 m³ for a domestic system at household level. The choice of a reservoir type and size depends on several technical and financial considerations:

- locally available materials and skills
- cost – of purchasing a new tank
- cost – of materials and labour for construction
- space availability
- locally available experience and options
- local traditions for water storage
- soil type and ground conditions
- type of RWH – whether the system will provide total or partial water supply

Both tanks and cisterns have specific advantages and disadvantages. The main disadvantage of cisterns is that water cannot normally be extracted by way of gravity; it requires either a bucket, hand pump, step pump or, if the topography and ground conditions are suitable, gravity can be used with the help of a pipe/tap arrangement. The table below summarises the advantages and disadvantages of each storage type.

The selection of a specific type of storage tank or cistern depends on many factors. Generally, larger storage tanks cost more than smaller ones. However, the construction cost per 1 m³ storage volume might be cheaper for larger tanks. The building material and methodology for constructing storage tanks also relates to the volume of the tanks.

Smaller tanks such as round-shaped water jars or pumpkin tanks (3 m³) can be constructed with ferro cement and chicken wire or bamboo sticks. Larger tanks (10 to 90 m³) typically require concrete, bricks or blocks and steel or wire.

Table 6: Advantages and disadvantages of tanks and cisterns

	Tank (surface)	Cistern (sub-surface)
Advantage	<ul style="list-style-type: none"> ➤ Above-ground structure allows for easy inspection for cracks or leakage ➤ Many existing designs to choose from ➤ Can be easily purchased 'off-the-shelf' in most market centres ➤ Can be manufactured from a wide variety of materials ➤ Easy to construct with traditional materials ➤ Water extraction can make use of gravity in many cases ➤ Can be raised above ground level to increase water pressure 	<ul style="list-style-type: none"> ➤ Generally cheaper ➤ Surrounding ground gives support allowing lower wall thickness ➤ Requires little or no space above ground ➤ Is not in the way (below the ground) / not as noticeable
Disadvantage	<ul style="list-style-type: none"> ➤ Requires space ➤ Generally more expensive ➤ More easily damaged ➤ Prone to erosion from weather ➤ Failure can be dangerous 	<ul style="list-style-type: none"> ➤ Water extraction (to draw water or for cleaning) is more problematic – often requiring a pump ➤ Leaks or failures are more difficult to detect ➤ Contamination of the tank from groundwater is more common ➤ Tree roots can damage the structure ➤ There is danger to children and small animals if tank cover is left off ➤ Flotation of the cistern may occur if groundwater level is high and cistern is empty ➤ Heavy vehicles driving near a cistern can cause damage

Cisterns made of ferro cement or concrete in clay soil are not recommended because of the seasonal expansion/contraction cycles of clay soil. Subsurface tanks in these soil types must be manufactured with thicker walls and a stronger framework.

6.2 Available materials and costs

Ferro cement is a low-cost steel and mortar composite material. Because ferro cement walls can be as thin as 1 cm, a ferro cement tank uses less material than concrete tanks, and thus can be less expensive. Tanks made of ferro cement consist of a framework (or armature) made from a grid of steel or bamboo sticks reinforcing rods tied together with wire around closely spaced layers of mesh or chicken wire. A cement-sand-water mixture is applied over the form and allowed to dry or cure. Repair of small cracks and leaks can easily be done by applying a mixture of cement and water, where wet spots appear on the tank's exterior. Developing a budget for a rainwater harvesting system may be as simple as adding up the prices for each of the components of the system and deciding what one can afford. The reservoirs typically determine the main costs of any RWH system.

Table 7: Examples from RAIN on cost ranges for different RWH systems used in Nepal (2004)

Local NGO	NGO-1	NGO-2	NGO-3	NGO-4
Tank capacity m³	60	25	25	6.5
Surface/sub-surface	Sub-surface	Sub-surface	Surface	Surface
Material	Reinforced cement concrete	Bricks	Ferro cement	Ferro cement
Community/ household level	Community level	Community level	Community level	Household level
Costs (in USD 2004)				
Construction materials	3209	936	2042	229
Labour	1083	478	786	173
Transportation	486	226	161	21
Supervision	1347	855	427	78
Communication	397	265	132	9
TOTAL	6521	2760	3548	509
Costs per m³	109	110	142	78
Labour days				
Unskilled labour	245	162	unknown	10
Skilled labour	95	68	unknown	21
Supervision	25	15	unknown	12
Total	365	245	unknown	42

Table 7 provides some examples of systems in Nepal from the Rainwater Harvesting Implementation Network (RAIN). RAIN has implemented rainwater harvesting in Nepal with local NGOs (BSP, NEWAH, Red Cross Nepal and Helvetas). More information on these NGOs is provided in the section Useful Addresses. Some general information about RAIN is given in Appendix 2. Table 8 gives some examples of storage reservoirs at household level and indicative costs. The costs include materials and labour only. The cheapest reservoir options are plastic lined tanks and steel (oil) drums.

Table 8: Examples of storage reservoirs

Type	Volume (m ³)	Indicative costs (USD)	Cost per m ³ (USD / m ³)
Plastic bowl/ buckets	10-25 litres	1-3	100
Steel (oil) drums	100 litres	10- 25	10
Plastic lined tanks	5	50	10
Water jar or jumbo jar (ferro cement)	3	150	50
Water tank (concrete in situ/ formwork)	5	300	60
Water tank built of bricks or blocks	10	500	50
Water tank built of ferro cement	11	550	50
Water tank built of ferro cement	23	750	33
Water tank built of ferro cement	46	1200	26
Sub-surface ferro cement tank	90	1900	21

6.3 Water extraction devices and tank overflow

In order to withdraw water from the storage reservoir, some form of extraction device is needed. In general this will be a tap for surface tanks and a pump for cisterns. The extraction device is a vital link in any RWH system.

Taps

A properly functioning and well-maintained tap is necessary for any surface catchment tank. A dripping or leaking tap can lose thousands of litres of harvested rainwater. Taps can break easily due to poor con-

struction and lack of maintenance. Water taps are often built on the tank-wall and only the water above the level of the tap can be tapped. The storage below this level is called 'dead storage'. Often the tap is raised to about 50 - 60 cm above the floor of the tank to allow buckets to be placed under the tap (see Figure 17). A portion of the tank volume is thus not available for extraction.

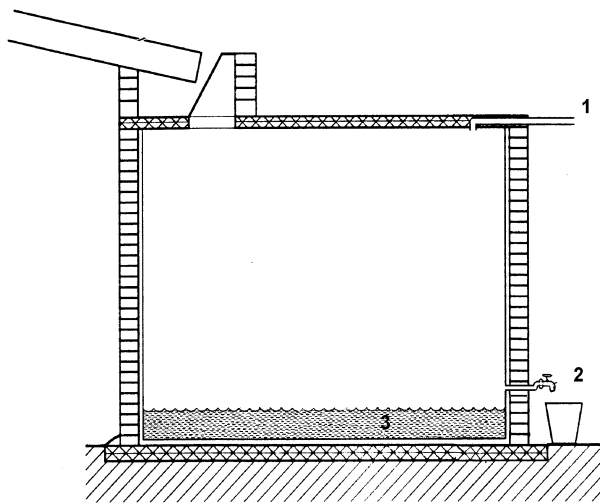

Figure 17: Overflow (1), Tap device (2), Dead storage (3)

For cleaning, emergencies and water for non-potable usage an (extra) extraction device at the bottom of the tank can be useful. To avoid 'dead storage' in the lower part of water tanks, taps can be positioned close to the floor of the tank. There are two ways of doing this: either the foundation of the tank can be elevated around 50 cm above the ground level, or the tap point can be situated below ground surface level. One should be aware that sediment will be extracted as well so this water cannot be used for drinking.

Water pumps

Pumps are used where water needs to be lifted from a sub-surface tank. One major advantage of sub-surface tanks with pumps over sur-

face tanks with taps is that no leaking may occur when the pump breaks. In many situations for communal supplies, this fact alone is a good reason to consider using sub-surface tanks with a pump. If the pump breaks it is still possible to extract water from the tank with a rope and bucket, though this may contaminate the water.

The most common type of pump for extracting water is the hand pump. Extraction using a rope and bucket is still common in many rural areas. Extracting water in this way is not advisable because it can pollute the stored water. Simple measures like using a clean bucket and preventing the rope from coming in contact with the ground will help prevent the water from becoming polluted.

Tank overflow

In surface tanks generally an overflow pipe at the top of the water tank is made. This allows excess rainwater to flow out of the tank when the tank is full. It is advisable to lead an overflow to a vegetable garden or far enough away from the area of the tank to avoid undermining the construction.

6.4 Description and examples of some rainwater reservoir designs

The following provides a description of the materials, construction and costs of some surface and sub-surface tanks. We recommend that you consult with a local engineer or experienced NGO before making a final selection of your RWH structure. An overview of global and regional organisations with experience in rainwater harvesting is provided in the section Useful Addresses. Some detailed construction manuals are given in the section Further Readings.

Surface tanks - Water jar or jumbo jar built of ferro cement (3-6.5 m³)

The design of the water jar is adapted from the smaller but immensely popular Thai Jar, more than 10 million of which have been built in Thailand.

The water jar or jumbo jar (also called pumpkin tank) is commonly used in households in Asia. This type of jar is especially popular among women, who find it easy to build on their own. The construction cost for a jumbo jar ferro cement tank of 4000 litres is about USD 150-225 and consists basically of concrete with chicken wire or bamboo sticks to provide the strength and shape of the structure. This circular water tank is built close to the catchment area/roof about 90 cm from the wall of the house or building.

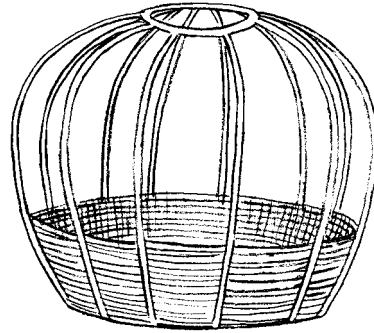

Figure 18: Construction of a water jar with a frame of iron bars or bamboo sticks

Several jumbo jars have been constructed in Nepal. The average rainfall in Nepal is about 1,200 mm per year. But the main rain falls in the months July and August. From October to May there is only very little rainfall. The RWH reservoirs ensure the water availability in these dry months.

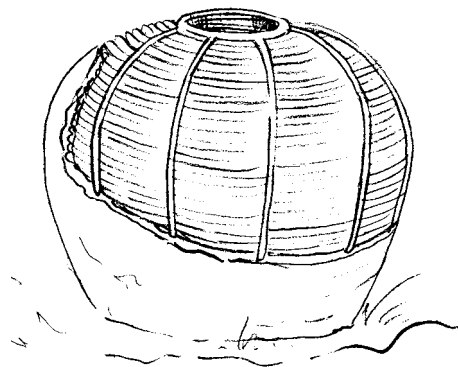

Figure 19: Construction of a water jar

The price per litre of water amounts to about USD 0.084. This price includes the cost of material, labour, transportation, supervision and communication.

The construction of these jars typically starts after the rainy season, which runs from May to September to ensure that the ferro cement can dry slowly and a solid tank construction is achieved.

More detailed construction stages for building a water jar are given in Appendix 1. The table below gives an indication of the required material, labour and total costs for the construction of a 3 m³ water jar built of ferro cement (source: Gould and Nissen-Peterson, 1999).

Table 9: Material, labour and total costs of a ferro cement water jar (3 m³) in Kenya

Item	Specification	Units	Quantity
Materials			
Cement	50 kg	Bags	6
Lime	25 kg	Bags	1
Sand	Coarse & clean	Tonnes	3
Crushed stones	10 to 20 mm	Tonnes	1
Rubble stones	100 to 500 mm	Tonnes	1
Bricks/blocks	Variable	Number	50
Water	200 litres	Oil drums	3
PVC pipe	50 mm	Metres	3
GI pipe	38 mm	Metres	0.5
GI pipe	18 mm	Metres	0.9
Tap	18 mm	Unit	1
Galvanised iron wire	3 mm	Kg	5
Chicken mesh	25 mm, 0.9 m	Metres	18
Mosquito mesh	Plastic	Metres	0.5
Coffee mesh	Galvanised 5 mm	Metres	1
Labour			
	Skilled masons	Working days	1 × 5
	Labourers	Working days	1 × 5
Formwork			
Canvas reusable for 10 jars	1.2 wide sewn into mould	Metres	15
Cost	150	USD (1998)	

Surface tanks - Water tank built of concrete in situ /formwork (5000 litres/ 5 m³)

In Kenya, water tanks are typically built of concrete. These structures are very simple to construct, although it requires mixing and pouring concrete into a mould or formwork (square or round). The tank should not be more than 1.75 m in depth in order to withstand the pressure of the water. Low depth also makes cleaning and use of the tank easier. This type of tank is very successful due to its simplicity. The table below can be used as a guide to determine the radius of the tank in relation to the required tank capacity.

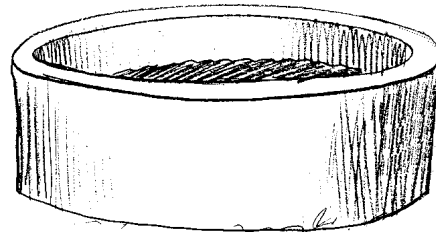

Figure 20: Water tank built of concrete

Table 10: Radius of concrete tank in relation to tank capacity

Capacity of tank (litres)	Radius of tank (metres)
5,000	0.9
6,000	1
7,000	1.125
8,000	1.2
9,000	1.275
10,000	1.35
11,000	1.425

See Appendix 1 for a step-by-step description of the construction of a 5 m³ round water tank of concrete in formwork. Table 11 gives an indication of the required material, labour and total costs for the construction of a 5 m³ water tank built of concrete (source: Gould and Nissen-Peterson, 1999).

Table 11: Material, labour and total costs of a water tank built of concrete in situ (5 m³) in Kenya

Item	Specification	Units	Quantity
Materials			
Cement	50 kg	Bags	12
Lime	25 kg	Bags	1
Sand	Coarse & clean	Tonnes	3
Crushed stones	10 to 20 mm	Tonnes	3
Rubble stones	100 to 500 mm	Tonnes	1
Bricks/blocks	Variable	Number	50
Water	200 litres	Oil drums	8
Welded wire mesh	2.4 × 1.2 m	Sheets	4
Barbed-wire	Gauge 12.5	Kg	20 (1 roll)
Galvanised iron pipe	38 mm	Metres	0.5
Galvanised iron pipe	18 mm	Metres	0.9
Tap	18 mm	Unit	1
PVC pipe	50 mm (2")	Metres	3
Mosquito mesh	Plastic	Metres	1
Coffee mesh	Galvanised	Metres	1
Lockable door	Steel	0.9 × 1.5 m	1
Labour			
	Skilled masons	Working days	1 × 8
	Labourers	Working days	2 × 8
Formwork			
Reusable for 20 tanks			
2 circular metal forms	Radius: Inner 90 cm Outer 100 cm Height 100 cm	Unit	1
2 circular bolts for form	Radius: 6 mm × 25 mm	Unit number	1 6
Timber and nails	6" × 1" timber 3" nails	Metres Kg	30 5
Cost	300	US dollar (1998)	

Surface tanks - Water tank built of bricks or blocks 10 m³

This type of water tank can be built for about USD 500 to 950 using locally available materials such as baked bricks, compressed-soil blocks, quarry, concrete or rubble-stone blocks (the latter being rubble stones converted into blocks). The technique for building the tank is similar to that of building a circular house of mud bricks, a skill that most rural artisans master. A local NGO in Nepal has built several traditional square water tanks with a capacity of about 25,000 litres. The materials cost about USD 940. This price includes the cost of material, labour, transportation, supervision and communication.

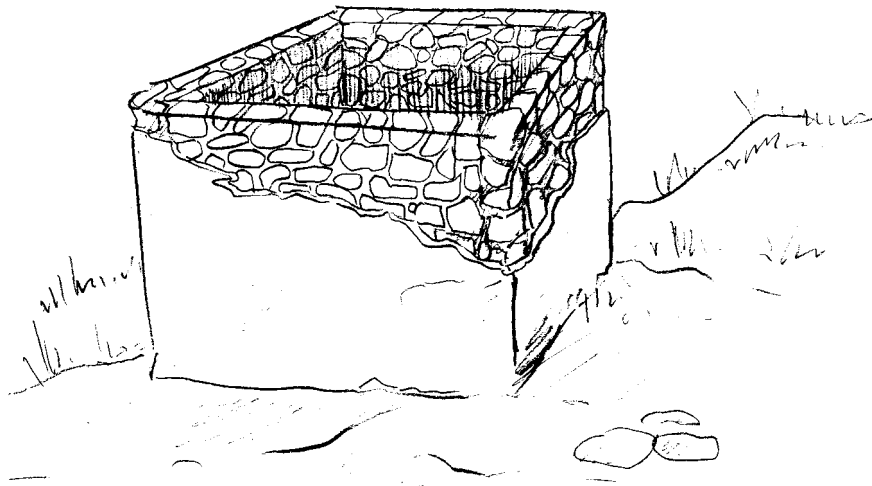

Figure 21: Construction of a water tank built of blocks

Table 12 gives an indication of the material and the costs for constructing a 10 m³ square water tank built of bricks (source Gould and Nissen-Peterson, 1999).

Table 12: Material, labour and total costs of a water tank built of bricks (10 m³) in Kenya

Item	Specification	Units	Quantity
Materials			
Cement	50 kg	Bags	21
Lime	25 kg	Bags	4
Sand	Coarse & clean	Tonnes	4
Crushed stones	10 to 20 mm	Tonnes	4
Stone blocks	100 to 500 mm	Tonnes	1
Burnt bricks	10 × 12 × 20 cm	Number	700
OR compressed soil blocks	12 × 14 × 29 cm	Number	455
OR concrete and stone	14 × 20 × 40 cm	Number	230
Water	200 litres	Oil drums	10
Welded wire mesh	2.4 × 1.2 m	Sheets	9
Barbed-wire	Gauge 12.5	Kg	30
Twisted bar	Y 12	Metres	13
GI pipe	38 mm	Metres	0.5
GI pipe	18 mm	Metres	4
Tap	18 mm	Unit	1
PVC pipe	100 mm (4")	Metres	2
PVC pipe	50 mm	Metres	3
Mosquito mesh	Plastic	Metres	0.5
Coffee mesh	Galvanised	Metres	1
Lockable door	Steel	0.9 × 1.5 m	1
Labour			
	Skilled masons	Working days	1 × 10
	Labourers	Working days	2 × 10
Formwork			
Reusable for 20 tanks			
Timber and nails for roof	6" × 1" timber 3" nails	Metres Kg	70 8
Cost	500	USD (1998)	

Water tank built of ferro cement (> 10,000 litres/ 10 m³)

Water tanks built of ferro cement are highly favoured and are being promoted by development agencies and organisations. It does, however, require practical training to build them.

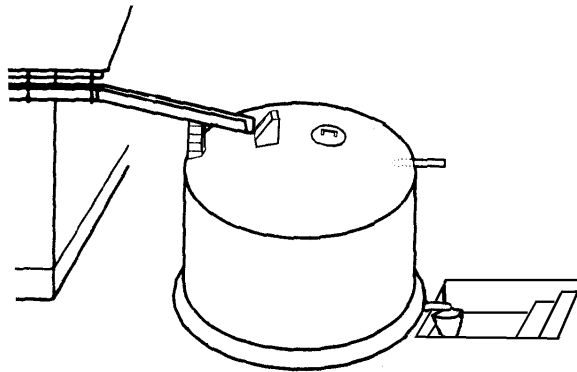

Figure 22: Water tank built of ferro cement with tap at the bottom

Table 13 gives an indication of the material, labour and total costs for constructing a 11 m³ water tank built of ferro cement (source Gould and Nissen – Peterson, 1999).

Plastic-lined tanks (5,000 litres/ 5 m³)

Plastic-lined tanks can be a low-cost (USD 50) alternative to metal or ferro cement tanks and require 12 m² of plastic sheet, 3 m of PVC tube and labour.

The organisation IDE in Asia is developing several models of plastic-lined tanks. One model consists of a 1500-litre reinforced plastic bag that fits inside a cylinder of sheet metal. Another model is a plastic liner reinforced with a 10 m³ plastic bag and installed in a hole in the ground. Open storage reservoirs can be made of earth. If clay is not available, a plastic lining is needed to stop water from leaking away. Linings can be made of standard plastic sheet glued together with the tar normally used to repair roofs. The plastic must be covered with

earth to prevent it from being exposed to the sun. Disadvantages of plastic-lined tanks are that they are not made of local material and they are not easy to repair if damaged.

Table 13: Material, labour and total costs of a water tank built of ferro cement (11 m³) in Kenya

Item	Specification	Units	Quantity
Materials			
Cement	50 kg	Bags	22
Lime	25 kg	Bags	1
Sand	Coarse & clean	Tonnes	5
Crushed stones	10 to 20 mm	Tonnes	2
Rubble stones	100 to 500 mm	Tonnes	1
Bricks/blocks	Variable	Number	50
Water	200 litres	Oil drums	15
BRC-mesh	No. 65	Metres	24
Chicken-mesh	25 mm, 0.9 m	Metres	38
Twisted iron	12 mm (0.5")	Metres	3
GI wire	3 mm	Kg	10
GI pipe	38 mm	Metres	0.9
GI pipe	18 mm	Metres	0.9
Tap	18 mm	Unit	1
PVC pipe	100 mm (4")	Metres	2.2
PVC pipe	50 mm (2")	Metres	3
Mosquito mesh	Plastic	Metres	0.5
Coffee mesh	Galvanised	Metres	1
Lockable door	Steel	0.9 × 1.5 m	1
Labour			
	Skilled masons	Working days	1 × 8
	Labourers	Working days	2 × 8
Formwork			
Reusable for 30 tanks			
Timber, bolts, sheets, etc., for dome	6" × 1" timber 2" × 3" nails Poles 2 metres Plastic bags Sisal twine Bolts 6 × 100 mm Oils drum sheets Plastic basin	Metres Metres Number Number Kg Number Number Number	12 16 8 20 2 8 7 1
Cost	550	USD (1998)	

Sub-surface tanks or cisterns

Cisterns for collecting and storing rainwater below the ground are constructed from brick or stone and can be square or preferably circular. Any construction starts by laying 2 PVC tubes on the ground (for the outlet and drain). Then stones are placed in a circle and secured with steel wire. The inside and outside of the tank is then plastered with cement. No steel bars are needed since the wire functions as reinforcement of the bricks or stones. Leaks are easily repaired with cement on the inside of the tank. An extraction device (pump, bucket) is required to take water from the reservoir.

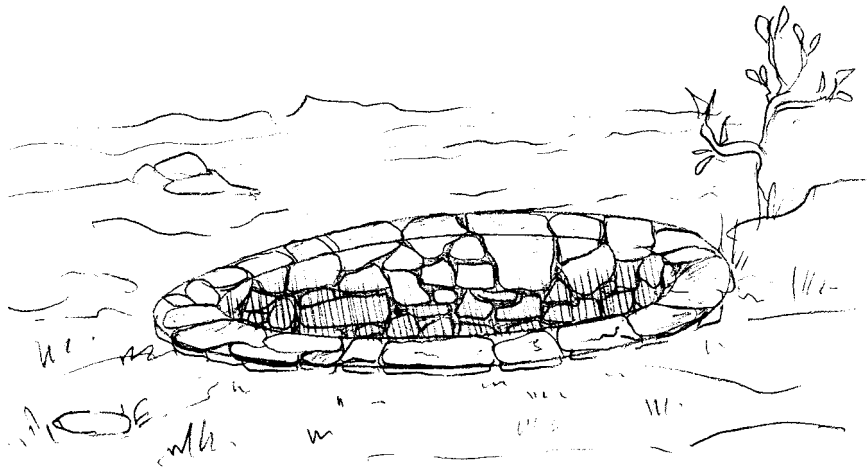

Figure 23: A round-shape sub-surface tank made of stone

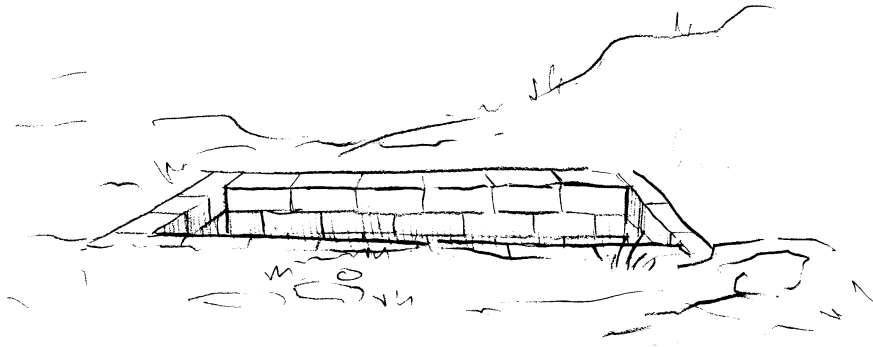

Figure 24: A square-shape sub-surface tank made of bricks

Sub-surface tanks can also be made from ferro cement. Stages of construction for a 90 m³ hemispherical sub-surface ferro cement tank are given in Appendix 1. A storage reservoir with such a volume is typically used for community-based water storage. Such a tank will cost around USD 1,900.

7 Water quality aspects

7.1 Protecting water quality

In rural areas rainwater is generally unpolluted and pure before reaching the ground. It is also in these areas that rainwater from roof catchments is most commonly used for drinking. Rainwater from well-maintained roof catchments is generally safe to drink without treatment. Except in heavily urbanised and industrialised areas or regions adjacent to active volcanoes, atmospheric rainwater is very pure and any contamination of the water usually occurs after contact with the catchment system. Regular cleaning and inspection of the catchment area and gutter are important to ensure good water quality.

The first rains should be used to flush away the dust, bird droppings, leaves etc. that lie on the roof surface. In practice, preparation and cleaning of the roof surface before the first rains hardly ever happens. To prevent these pollutants and contaminants from getting into the storage tank, the first rainwater containing the debris must therefore be diverted or flushed away. Many RWH systems therefore incorporate a system to divert this ‘first-flush’ water so that it does not enter the tank. A coarse filter, preferably made of nylon or a fine mesh, can also be used to remove dirt and debris before the water enters the tank.

Common sources of rainwater contamination:

- dirt and faeces (mainly from birds and small animals) on the roof surface
- leaf debris and organic material washed into the tank
- animals, insects and birds that have drowned in the water
- breeding mosquitoes
- dirty containers and buckets, etc.

A certain degree of microbiological and chemical contamination of roof rainwater run-off is inevitable. It will, however, generally not cause any health problems if the roof, gutters and storage are properly maintained and regularly cleaned and inspected. To prevent breeding

mosquitoes it is important that any openings in the tank are fully screened. In addition, proper coarse filter devices are a must. Also the positioning of the tap device is important. Since particles in the tank settle at the bottom, the tap device should be positioned at least 15 cm above the floor level of the tank. For drinking water it is advisable to place the tap device about 50 cm above the tank bottom.

Galvanised iron (GI) sheet roofs function best as a catchment surface, due to their relative smoothness and the sterilising effect of the metal roof when it is heated by the sun. The poor performance of organic roofs would seem to preclude them from use for rainwater harvesting systems; however, organic roofs have been employed with varying levels of success. The water is usually used for secondary purposes but can be used as drinking water.

Table 14: Catchment type and effect on water quality

Type	effect on water quality
GI Sheets and aluminium	Excellent water quality Surface is smooth and high temperatures help to sterilise the water (kill bacteria)
Tiles (glazed)	Good water quality Unglazed tiles can harbour mould Contamination can exist in tile joins
Asbestos-cement sheets	New sheets give good quality water No evidence of carcinogenic effects from ingestion Slightly porous so reduced run-off coefficient Older roofs harbour moulds and even moss
Organic material	Poor water quality Little first-flush effect High turbidity due to dissolved organic material which does not settle

To protect water quality, good system design, operation and maintenance are essential. Water quality will generally improve during storage, provided that light and living organisms are excluded from the tank, organic content is limited, and fresh inflows do not stir up any sediment. The use of filters and first-flush devices will further improve water quality. Further treatment through boiling, exposure to

sunlight and chlorination can be undertaken if there are concerns about the water quality.

Checklist: What measures should be taken to prevent contamination of the stored water?

- 1 A roof made from non-toxic material is essential.
- 2 Roof surface should be smooth and any vegetation should be removed.
- 3 Taps and draw-off pipes on storage tanks should be at least 15 cm above the tank floor and not close to the inflow point.
- 4 A coarse filter and/or first-flush device should be applied to remove dirt and debris before water enters the tank.
- 5 Wire/nylon should cover all inlets to prevent insects (breeding mosquitoes) and other animals from entering the tank.
- 6 The tank must be covered and all light must be excluded to prevent growth of algae and micro-organisms.
- 7 Tanks, gutters and other system components should be inspected and cleaned annually.
- 8 The first days following major rainfall, water should not be consumed directly from the tank without treatment.
- 9 Water from other sources should not be mixed with that in the tank.
- 10 Use clean buckets and taps to draw water from the storage tanks.

7.2 Filters

The quality of water can be much improved if debris is kept out of the system. To accomplish this filters and separators can be added to a rainwater harvesting system at the inlet, outlet or both. Filters simply catch the debris and allow all water to flow through.

The first line of defence is a coarse filter, which can be installed anywhere from the gutter to the entrance to the tank. The most popular position for

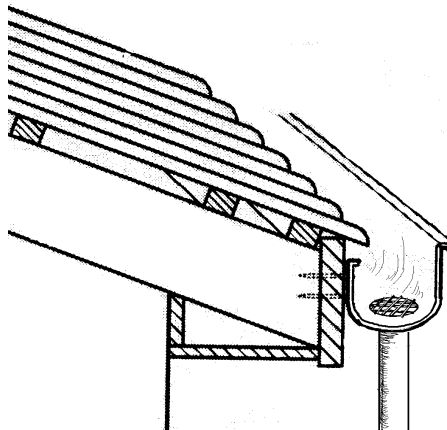

Figure 25: Coarse filter

placing a filter is in the gutter, at the beginning of the downpipe, in the downpipe and at the entrance to the tank itself. Of these, the tank entrance is by far the most common in very low-cost systems. Whatever location is chosen for the filter, there are several criteria that should be met for good design: The filter should be easy to clean, it should not get blocked easily (if at all), blockages should be obvious and easy to rectify and it should not provide an entrance for additional contamination of the stored rainwater.

7.3 First-flush

The primary purpose of a first-flush diverter is to take the first flow of rainwater from the roof and divert it away from your storage reservoir. The first-flush of water from the roof can contain bacteria. First-flush and filter systems are not always absolutely essential but they can significantly improve the quality of roof run-off. If these systems are poorly operated and maintained, they may result in the loss of rainwater run-off and even contaminate the water supply. There are several methods for separating the first-flush: the fixed volume or automatic method, the manual method, the fixed mass system and the SafeRain system.

Fixed volume or automatic method

Of the four methods mentioned above, the fixed volume method is considered the simplest and is the most widely recommended. It is completely automatic, and less prone to damage than other methods. A chamber of a set size (usually a length of downpipe) is filled with rain until it overflows and is thereby flushed. This 'automatic' method is usually applied in low-cost systems. The method can be used either with or without a floating ball seal which helps in reducing mixing between early flush or dirty water and later clean water. Making a small hole in the bottom of the downward pipe allows the first-flush to be drained slowly, allowing the system to function as a first-flush during the next rains as well. The bottom of the downward pipe should be removable to enable cleaning and draining of accumulated slurry.

Manual method

The manual method relies on the user being home and prepared to go out into the rain to operate it (see Figure 26). At the beginning of the rainfall the down-pipe is moved away from the storage reservoir; to flush the roof, guttering and pipes. After 5 minutes the down-pipe is reconnected to the storage reservoir, which can then gradually fill.

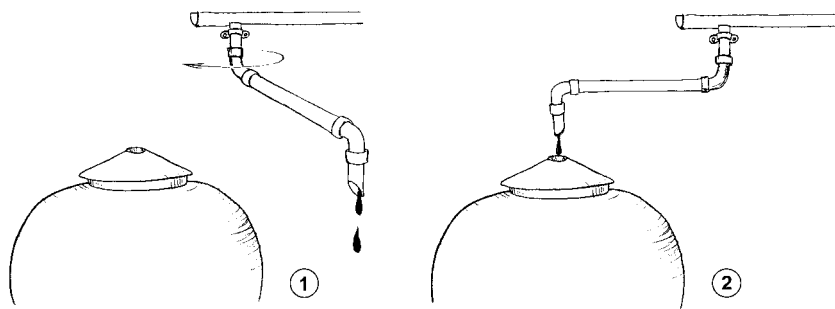

Figure 26: Manual method for separating first-flush

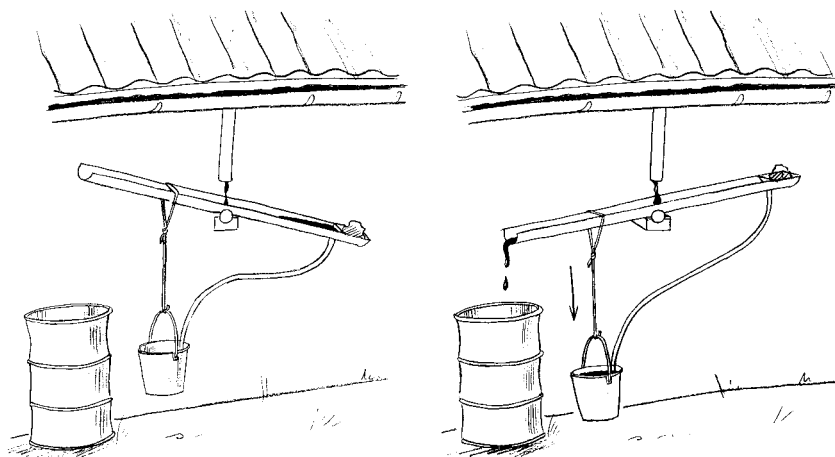

Figure 27: Fixed mass system for separating first-flush relying on the mass of the water

Fixed mass system

The fixed mass system usually relies on a mass of water to tip a bucket or seesaw (Figure 27). It tends to be unreliable as it is easily damaged.

SafeRain system

The SafeRain system makes use of a hollow ball that floats on the initially collected rainwater in a fixed container (see Figure 28). When the water level rises, the ball blocks the opening and allows water to flow into the tank. The system has the advantage of being self-cleaning and removes the need for any storage of the first-flush water (and its subsequent drainage).

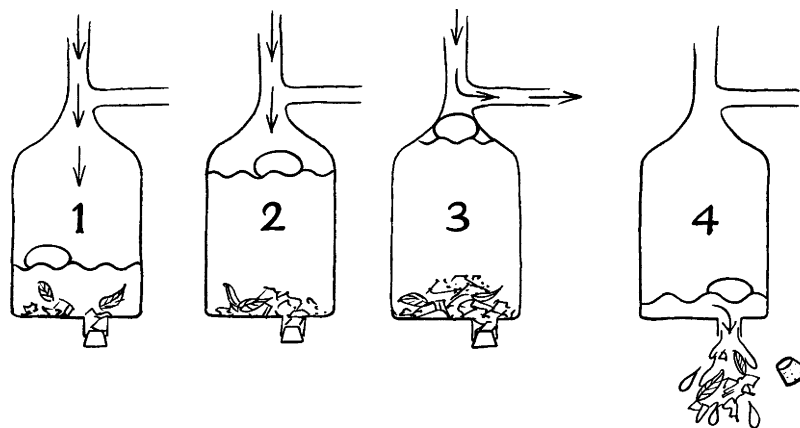

Figure 28: SafeRain system for separating first-flush

7.4 Treatment of stored water

Treatment of stored rainwater makes sense only if it is done properly. There are several possible treatment methods, the most common being sand filters, chlorination, boiling and exposure to sunlight.

Sand filters

Sand filters provide a cheap and simple method to purify water. Two filter types can be used: a filter can be connected to the tank to filter

ALL the water as it enters the tank. Such a filter can provide 50 litres of water per day – enough for the drinking and cooking needs of a small family. However, this filtering method is only suitable where the inflow is slow. The second filtering type is a so-called point of use filter, which unlike the first option is not located at the inflow point. Water for drinking purposes is filtered through a portable sand filter. This second type is highly recommended.

In a sand filter, additional layers of gravel and charcoal are also commonly used to further improve the filtering capacity and thus the water quality. Sand filters do require careful operation and maintenance to ensure they continue to work effectively.

Chlorination

Chlorination can be an effective way to purify the water. The chlorine will, however, affect the taste of the water and over-application can cause health problems. If you suspect the water in your tank is contaminated, adding calcium hypochlorite or sodium hypochlorite should treat it. The initial dose should be 7 g of calcium hypochlorite or 40 ml of sodium hypochlorite per 1000 litres of water in the tank. The water should be stirred and left to stand for 24 hours (no additional water may enter the reservoir). To maintain a safe water supply after this initial dosage, 1 g of calcium hypochlorite or 4 ml of sodium hypochlorite per 1000 litres should be added to the rainwater tank weekly and the mixture should be allowed to stand for at least two hours before use. Stabilised chlorine (chlorinated cyanurates) should not be used. Some important rules for using chlorine:

- Do not pour water onto chlorine, but always add chlorine to water.
- Avoid skin contact.
- Store chlorine in a cool, dark place, out of reach of children.

To ensure that sufficient chlorine has been added, the water is normally tested with a simple colour-coded testing kit for residual chlorine. Normally a chlorine residue in the range of 0.2 – 0.5 mg/litre indicates safe drinking water.

Boiling

Boiling water for two or three minutes normally ensures that it is free from harmful bacteria or pathogens. However, boiling requires a lot of energy and in some areas this might be a problem due to shortage of fuel or wood. Many people do not like the flat taste of boiled water and it takes time for it to cool down before you can drink it.

Sunlight

Another way to kill many harmful bacteria in water is to put it into clear glass or plastic bottles and place them in direct sunlight for several hours. This method is known as Solar Water Disinfecting (SODIS). The process works in two ways: bacteria and microorganisms are killed both by exposure to direct radiation and, if heated sufficiently, by water temperatures exceeding 70°C. It is most effective when the water is fully oxygenated, so leaving some air in the bottles and shaking the bottle occasionally will speed up the process. Painting the bottles black increases absorption of radiation and increases the heat. (See www.sodis.ch for more detailed information.)

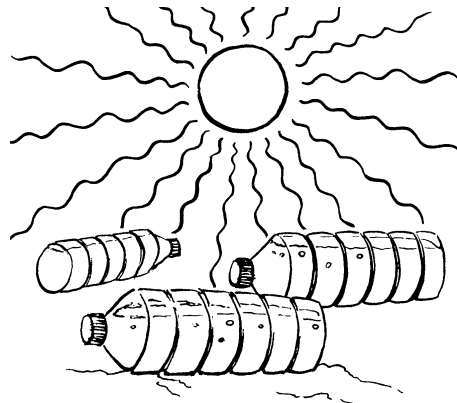

Figure 29: Solar Water Disinfection (SODIS): an easy way to kill harmful bacteria in water

8 Usage and maintenance

Continued operation and maintenance of any rainwater harvesting system is very important and quite often neglected. The amount of maintenance required by a basic, privately owned household or community centre roof catchment system is limited to the annual inspection of the roof, gutters, mosquito screening and the removal of any leaves, dirt or other matter, and the cleaning of the tank. In seasonal climates, where roof surface may become dirty and dusty in dry seasons, the cleaning and sweeping of the roof, gutters and tank before the first major rains is advisable.

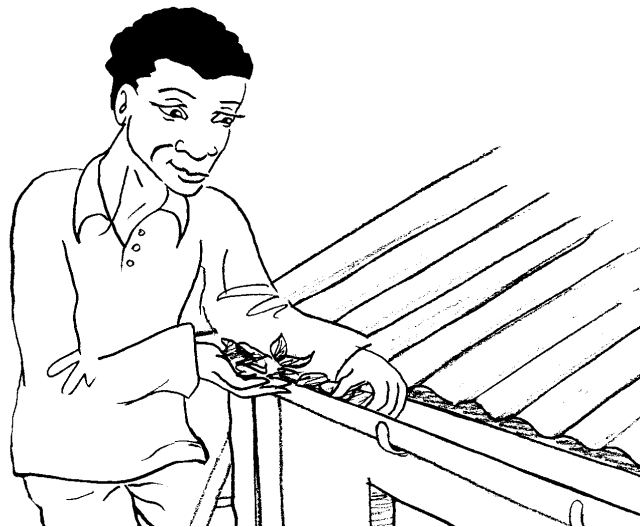

Figure 30: Remove debris from the gutter system regularly

If various components of the RWH system are not regularly cleaned, possible problems are not identified or necessary repairs are not performed and the system will cease to provide a reliable, good-quality supply of water. The following timetable of maintenance and management requirements gives a basis for monitoring checks:

During rainy season: the whole RWH system (roof catchment, gutters, pipes, screens, first-flush and overflow) should be visually checked after each rain and if necessary, preferably at least cleaned after every dry period greater than one month.

End of dry season: The storage tank should be scrubbed out and flushed of all sediment and debris at the end of each dry season just before the rain comes. A full service of all tank features is recommended just before the first rains are due to begin, including replacement of all worn screens and servicing of the outlet or hand pump.

Year round: The water tank should regularly be checked for leaks and cracks, which need to be repaired. Only small weeping leaks, which may occur on first filling the tank, need not be repaired since they usually seal themselves. If there is any doubt about the presence of organic contaminants in the water source, the water can be chlorinated. Water must not be allowed to leak from tap fittings. Not only will this waste water, but it may also provide a basis for algae growth in the sink or drainage system and lead to development of bacteria, which form a hygiene risk.

The following section provides a schedule of operation and maintenance tasks for storage reservoirs and associated roofs and gutters.

8.1 Regular maintenance

- 1 Roof surfaces and gutters have to be kept free of bird droppings. Gutters and inflow filters must be regularly cleared of leaves and other rubbish.
- 2 The mosquito screening on the overflow pipe should be checked regularly during the rainy season and renewed if necessary.
- 3 Unless there is some automatic means of diverting the first flush of water in a storm away from the tank, the inflow pipe should be disconnected from the tank during dry periods. Then a short period after rain begins and the system has been flushed, it can be moved back so the water flows into the tank.

- 4 The water level in the tank should be measured once a week using a graduated stick. During dry periods, the drop of water level should correspond with water consumption. If not, there might be some leakage.

8.2 Infrequent and annual tasks

The following annual or infrequent tasks for which technical assistance may be required are important for the maintenance of the RWH system:

- 1 At the end of the dry season, when the tank is empty, any leaks that have been noticed should be repaired.
- 2 The roof surface, gutters, supporting brackets and inflow pipes need to be checked and repaired if necessary.
- 3 If a sand filter is incorporated, the filter should be washed with clean water or renewed. Other types of filters should be checked.
- 4 Removal of deposits from the bottom of the tank is periodically necessary and should preferably be done annually.
- 5 After repairs have been carried out inside the tank and after deposits have been cleared out, the interior should be scrubbed down with a solution of 3 parts vinegar to 1 part water, or 1 kg baking powder to 9 litres of water, or 1 cup (75 ml) of 5% chlorine bleach to 45 litres of water. After scrubbing, leave the tank for 36 hours and finally flush it out with water before using it again to store water.

Appendix 1: Checklist for construction of storage reservoirs

Construction of water jar or jumbo jar built of ferro cement (3000 – 6500 litres/3 m³)

Follow these steps to construct a water jar or jumbo jar:

- 1 Draw the contour of a circular foundation with a radius of 75 cm by using a string of 75 cm and a peg in the centre of the jar.
- 2 Dig out the soil within the circle until firm soil is reached, or the height to the eaves of the roof is 220 cm.
- 3 Level the excavation and fill it with 10 cm of concrete, using a mix of 1:3:4 (sand: cement: water). Reinforce the concrete with two layers of chicken wire. Allow 300 mm of chicken wire to stick out all around the edge of the base. This will be connected to the wall mesh later.
- 4 Lay 10 anchor bolts for the legs in the base while casting (the diameter will depend on the diameter of the holes in the legs).
- 5 Make it level and compact it well. Let the base set for 7 days, wetting it each day.
- 6 Prepare skeleton / framework legs from five long pieces of chicken wire (or bamboo). Cut 5 lengths of 7 m-long 3 mm galvanised wire. Bend the wire-ends to avoid injuries. Mark the middle of each wire using pliers. Tie the 5 wires together at the marks like spokes in a wheel. Make a ring of 3 mm wire, 116 cm in diameter, and place upon spokes and tie together.
- 7 The draw-off pipe is made of a piece of 18 mm GI pipe that is 90 cm long. An elbow and a nipple are screwed onto the inner end, and a socket and a tap to the outer end. Place the pipe upon the foundation.
- 8 Place the wires and mesh on the foundation and stuff it with light, dry material, e.g. sawdust, hay or dung. Sand may be used if buckets can handle the weight.
- 9 Secure the 10 skeleton legs using the bolts and the crown ring. Take a 6 mm steel rod and wrap it around the outside of the legs, starting at the bottom and working up.

- 10 Fix 2 layers of chicken mesh over the outside of the skeleton. The filter tower can be added at this point if a filter is to be fitted.
- 11 Plaster the outside of the mesh. Mortar (1:3) is smeared onto the mould in a thin layer. After a couple of hours more mortar is plastered on to the mould until the mortar is 2 cm thick.
- 12 While the plaster sets for 3 days, build the tap station.
- 13 Remove the skeleton from the inside of the tank. The jar is cleaned before mortar 1:3 is plastered onto the inside in 2 layers, each layer being 1 cm thick. Water proofing can be added to the mortar. This can be a special additive or liquid dishwashing soap.
- 14 Cure the tank for 7-10 days.
- 15 Place 2 concentric rings of plain sheet metal that 10 cm high and 60 cm in diameter on top of the jar. Fill the space between the two sheets with mortar (1:3) to form a manhole and a lip.
- 16 Place a pipe for an overflow through the lip.
- 17 Cover the manhole with mesh to prevent insects and debris from entering the jar.
- 18 After 7 days fill the tank gradually (first flush!) at a rate of approximately 300 mm per day by controlling the inflow into the tank in case the rainfall is very intensive during the first rainfall season.

Construction of Water tank built of concrete in situ /formwork (5000 litres/5 m³)

This type of tank is typically built in Kenya and is very simple to construct, although it requires mixing and pouring concrete into a mould or formwork (square or round). A circular water tank of concrete in situ is built close to the catchment area/roof about 90 cm from the wall of the house or building. The following steps need to be followed:

- 1 Two circular sets of steel plate are needed for making the formwork.
- 2 Corrugated galvanised iron sheets used for roofing can be rolled into semi-circular shapes in a special machine used by workshops that make cylindrical water tanks from GI corrugated-iron sheets. Much cheaper formwork can be made from old oil-drums by an artisan skilled in metal work. The tops and bottoms are cut out of four oil drums and the seam of each drum cut open. Two circles are drawn on the ground; one having a radius of 90 cm for the inner form and the other circle having a radius of 100 cm for the outer form.
- 3 The artisan beats the oil-drums to fit half of each circle. Each set of oil-drums is bolted together to form a circle.
- 4 Draw out the circular foundation with a radius of 117 cm by using a string of 117 cm and a peg in the centre of the jar. The foundation should be 90 cm away from the wall of the building from which rainwater will pour into the tank.
- 5 Dig out the soil at least 15 cm deep within the circle, and 250 cm below the eaves of the roof. The floor of the excavation is then made level.
- 6 Two sheets of welded wire mesh, tied with overlaps of 20 cm, are cut into circles with a radius of 112 cm, 5 cm shorter than the excavation.
- 7 A draw-off pipe is made of a piece of 18 mm GI pipe that is 90 cm long. An elbow and a nipple are screwed on to the inner end, and a socket and a tap fixed to the outer end.
- 8 Now compact a 7-cm layer of concrete (1:3:4) into the excavation. Place the circular sheet of welded wire mesh on the concrete. Then

- place the draw-off pipe on the welded wire mesh where the tap stand will be.
- 9 Compact a 6-cm layer of concrete (1:3:4) onto it and level it off with a rough surface. Keep the foundation moist under cover while building the remaining part of the tank.
 - 10 Place the two circular moulds on the foundation, 10 cm apart.
 - 11 Fill the mould with concrete (1:3:4) while laying a spiral of barbed wire (12.5 g) with a vertical spacing of 10 cm in the concrete. Knock the mould to remove any air bubbles from the concrete.
 - 12 On the following day, remove the mould and place it on top of the concrete wall.
 - 13 Now repeat the procedure of filling the mould with concrete and a spiral barbed wire with a vertical spacing of 10 cm.
 - 14 Remove the mould. Plaster the interior of the tank with a 2 cm-thick layer of mortar (1:3) and NIL (cement slurry) on the same day.
 - 15 Make a framework of timber (6 x 1 inch).
 - 16 Support it with props in the tank. The timber should be flush with the top of the tank wall.
 - 17 Cut two sheets of welded wire mesh into a circular sheet that is 5 cm shorter than the outer edge of the tank wall.
 - 18 Cut a hole for a plastic basin, to act as the mould for the manhole, in the welded wire mesh and place it on the formwork.
 - 19 Place the overflow pipe under the welded wire mesh vertically over the tap in the foundation.
 - 20 Pour 10 cm of concrete (1:3:4) into the basin and on the formwork. Lift the welded wire mesh into the middle of the concrete and smooth it to finish.
 - 21 Build the tap stand and gutter inlet while curing the tank.
 - 22 After seven days remove the formwork and whitewash the external surfaces of the tank with 1 part cement to 10 parts lime.

Construction of water tank built of bricks or blocks (10 m³)

Follow these steps to construct a square 25,000-litre tank:

- 1 Excavate a foundation for the tank that is 4 m long, 4 m wide and 2 m deep and is situated at least 1 m from the gable of a house.
- 2 Cover the walls of the excavation with blocks and cement.
- 3 Place 10 mm rods tightly against the walls of the tank. Plaster the wall and floor with a 2-cm layer of mortar (1:3). Press cement slurry into the moist mortar with a steel trowel for waterproofing.
- 4 Cover the tank with mesh to prevent insects and debris from entering.
- 5 After 7 days fill the tank gradually (first flush!) at a rate of approximately 300 mm per day by controlling the inflow into the tank in case the rainfall is very intensive during the first rainfall season.

Appendix 2: About RAIN



RAIN (Rainwater Harvesting Implementation Network) is an international network established to increase access to water for vulnerable sections of society in developing countries - women and children in particular – by helping them to collect and store rainwater in water tanks and wells.

Our mission

RAIN aims to improve access to domestic water in communities worldwide through widespread:

- implementation of local rainwater harvesting projects
- establishment and capacity building of rainwater harvesting capacity centres
- knowledge sharing.

What we do

RAIN provides funds for the implementation of small-scale rainwater harvesting projects through local organisations. **RAIN** is presently implementing rainwater harvesting projects in Nepal, Senegal and Ethiopia and would like to expand to Asia and Sub-Saharan Africa in the near future. In addition, our programme facilitates a global exchange of knowledge on rainwater harvesting between our partners and other interested organisations.

In 2004 **RAIN** facilitated the construction of 1 million litres of rainwater harvesting capacity by local organisations, benefiting about 8,500 people. Tanks of 16,000 to 128,000 litres have been established at schools, community centres and health posts. In other areas where only household level tanks are feasible, tanks with a capacity of up to 6,500 litres have been installed.

RAIN ensures the integration of rainwater harvesting in water and sanitation, educational and health programmes through partnerships with international organisations such as the Southern and Eastern Africa Rainwater Network (SearNet) and local organisations such as the Ethiopian Rainwater Harvesting Association (ERHA), the Senegalese *Association Culturelle d'Aide a la Promotion Educative et Sociale* (ACAPES) and the Nepalese Biogas Sector Partnership (BSP).

Our Organisation

RAIN receives and distributes funds through the RAIN Foundation, which is registered in the Netherlands. The RAIN Foundation is administered by a Board and advised by an International Advisory Committee consisting of international key players in the international water sector. PLAN-Netherlands is the principal donor of the RAIN Foundation.

Contact

Rainwater Harvesting Implementation Network
c/o Donker Curtiusstraat 7-523
1051 JL Amsterdam
The Netherlands
Tel. +31 20 6868111
Fax. +31 20 6866251
info@rainfoundation.org
www.rainfoundation.org

Further reading

Very Low-cost Domestic Roofwater Harvesting in the Humid Tropics: Existing Practise, Development Technology Unit, 2002, Domestic Roofwater Harvesting Research Programme, University of Warwick. www.eng.warwick.ac.uk/dtu/rwh/index.html

Rainwater Harvesting CD, by Hans Hartung, 2002. Margraf/CTA. ISBN: 3-8236-1384-7

Rainwater Catchment Systems for Domestic Supply, by John Gould and Erik Nissen-Petersen, 1999. Design, construction and implementation. ISBN: 1853394564

Water Harvesting. A guide for planners and project managers, 1992. IRC, International Water and Sanitation Centre, Delft, The Netherlands. ISBN: 90-6687-020-6

Rainwater Harvesting, Technical Note, Intermediate Technology Development Group (ITDG, www.itdg.nl)

General

Guidance on the use of Rainwater Tanks, 2004, Australian Government Department of Health and Ageing. ISBN: 0 642 82443 6

Rural Water Supplies and Sanitation, Morgan, 1990, Macmillan Education Ltd, London. ISBN: 0333485696

Water Harvesting in Five African Countries, by M. Lee and J. Visscher, 1990, Occasional Paper Series 14, IRC, The Netherlands

Rainwater Reservoirs, Above Ground Structures for Roof Catchment, by R. Hasse, 1989, gate, Germany. ISBN: 3528020490

Sourcebook of Alternative Technologies for Freshwater Augmentation in Africa, UNEP, 1998. ISBN: 9280715089

Manuals and design information

Water Storage – Tanks, Cisterns, Aquifers and Ponds for Domestic Supply, Fire and Emergency Use, by Art Ludwig – Includes how to make ferro cement tanks. ISBN: 0964343363

Guidance on the use of Rainwater Tanks, by D. Cunliffe, 1998, National Environmental Health Forum Monographs, Water series 3, Australia. ISBN 0642320160

Rainwater Tanks: Their Selection, Use and Maintenance, 1998, South Australian Water Cooperation, Australia.

Useful addresses

ACORD Mbarara, Uganda
P.O. Box 1394, Mbarara, Uganda
T: 041-267667/8, 075640989, F: 041-267738/267863
W: www.acord.org.uk

CSE Centre for Science and Environment
Spreading awareness about the immense relevance of rainwater harvesting in the present context.
41, Tughlakabad Institutional Area, New Delhi-110061, India
W: www.cseindia.org and www.rainwaterharvesting.org

ERHA: In Ethiopia, the RAIN programme is monitored and guided by the Ethiopian Rainwater Harvesting Association. ERHA is RAIN's Rainwater Harvesting Capacity Centre in Ethiopia
Zerihun Building (2nd Floor, Room No. 30),
Haile Gebreselassie Avenue
Wereda 17, Kebele 14, H. No. 493/30
P.O. Box 27671/1000, Addis Ababa, Ethiopia
T: + 251-1-63 85 13/4, F: + 251-1-63 85 14
E: erha@telecom.net.et, W: www.searnet.org/organisations.asp

FAKT
Sustained improvements of social and economic conditions in developing and transformation countries
Gänsheidestrasse 43, 70184 Stuttgart, Germany
T: +49 (0) 711 21095-0, F: +49 (0) 711 21095-55
E: fakt@fakt-consult.de, W: www.fakt-consult.de

GARNET Global Applied Research Network for the theme 'Rainwater Harvesting.' Water, Engineering and Development Centre
Loughborough University, Leicestershire, LE11 3TU, UK
T: +44 1509 222393, F: +44 1509 211079
W: www.lboro.ac.uk/departments/cv/wedc/garnet/tncrain.html

IRC International Water and Sanitation Centre

Provides news, advice, research and training on low-cost water supply and sanitation in developing countries

See also Technical Paper Series 40: 'Small Community Water Supplies'

P.O. Box 2869, 2601 CW Delft, The Netherlands

T: +31 15 219 2939, F: +31 15 219 0955, W: www.irc.nl

IRCSA International Rainwater Catchment Systems Association

To promote and advance rainwater catchment systems technology worldwide.

W: www.ircsa.org

IRHA International Rainwater Harvesting Alliance

To promote rainwater harvesting, within the context of IWRM, linking local social, gender, and economic development with the protection of vital ecosystems.

IRHA Secretariat and HQ - Geneva - Switzerland

7-9 chemin de Balexert, 1219 Châtelaine, Geneva, Switzerland

W: www.irha-h2o.org

PRACTICA Practica foundation facilitates knowledge exchange and the development of innovative and low-cost water technologies.

Maerten Trompstraat 31, 2625 RC Delft, The Netherlands

T: +31 (0)15 257 53 59, W: www.practicafoundation.nl

RAIN Rainwater Harvesting Implementation Network

For more information, see chapter About RAIN

RELMA Regional Land Management Unit (RELMA) has been integrated into the World Agroforestry Centre (ICRAF)

ICRAF House, UN Avenue, Gigiri

P.O. Box 30677-00100 GPO, Nairobi, Kenya

T: (+254 20) 524400/524418, F: (+254 20) 524401/524001

W: www.relma.org

RWP The Rainwater Partnership was formed on October 7, 2004, at the UNEP offices in The Hague as a 'Type II' partnership between UNEP, SearNet, IRHA, IRCSA, and RAIN. Type II partnerships first emerged at the World Summit on Sustainable Development (WSSD, Johannesburg, 2002). They strive to complement the work at the government and policy level with more direct action on the ground.
c.o. Division of Environmental Policy Implementation (DEPI)
United Nations Environment Programme (UNEP)
Elizabeth Khaka, P. O. Box 30552, Nairobi, Kenya
T: 254 2 623990/621234, F: 254 2 624 249/622788

SEARNET Southern and Eastern Africa Rainwater Network (SearNet), a network of national rainwater harvesting (RWH) associations in Eastern and Southern Africa
Regional Land Management Unit, Icrat House , UN avenue, Gigiri
P. O. Box 63403, Nairobi 00619, Kenya
T: (+254 20) 722 44 00 / 722 44 22, F: (+254 20) 722 44 01
W: www.searnet.org

SIMAVI supports healthcare initiatives in developing countries with a focus on water and sanitation activities
Fonteinlaan 5, 2012 JG Haarlem, The Netherlands
T: 023 5318055, F: 023 5328538, W: www.simavi.org

RAIN's implementing partners during the pilot phase (2005) in Ethiopia:

AFD: Action for Development
P.O.Box 19859, Addis Ababa, Ethiopia
T: (251-1) 622326 / 625976, F: (251-1) 625563

ASE: Agri-Service Ethiopia
PO Box 2460, Addis Ababa, Ethiopia
T: (251-1) 651212 / 65 55 15, F: (251-1) 654088
W: www.devinet.org/agriservice

ERSHA: Ethiopian Rural Self Help Association
Debre Zeyet Road, off Mickwor Plaza Building
P.O. Box: 102367, Addis Ababa
T: (251-1) 654652 / 661493, F: (251-1) 251 1 661492
E: ersha@ersha.org, ersha@telecom.net.et
W: www.devinet.org/ershaethiopia

WaterAction - Ethiopia

Higher 17, Kebele 21, House No 432/4, Behind AMICE
Addis Ababa, Ethiopia
T: (251-1) 61 42 75, F: (251-1) 66 16 79, E: wact@telecom.net.et

RAIN's implementing partners during the pilot phase (2004) in Nepal:

Biogas Sector Partnership, Nepal (BSP)

(RAIN's Rainwater Harvesting Capacity Centre)
Bakhundole, Lalitpur, P.O. Box 9751, Kathmandu, Nepal
T: (+977)-(1)-5529840/ 5524665, F: (+977)-(1)-5524755
E: snvbsp@wlink.com.np

Helvetas Nepal

P.O. Box 688, Kathmandu, Nepal
T: (+977)-(1)-527828, F: (+977)-(1)-526719
E: helvetas@warm.wlink.com.np

Nepal Red Cross Society

National Headquarters, Red Cross Marga, Kalimati
P.O. Box 217, Kathmandu, Nepal
T: (+977)-(1)-4270650 / 4270167, F: (+977)-(1)-4271915
E: nrcs@nrcs.org, W: www.nrcs.org

NEWAH – Nepal Water for Health

P.O. Box: 4231, Lohasal, Kathmandu, Nepal
T: (+977)-(1)-4377107 / 4377108, F: (+977)-(1)-4370078
E: newah@newah.org.np, W: www.newah.org.np

Glossary

Arid	Very dry climate with less than 500 mm average annual rainfall.
Catchment surface	The surface which receives rainfall directly and contributes the water to the system. Any roofing material can be used for non-potable uses. Water to be used for drinking should not be collected from roofs covered with asphalt, and lead flashing should not be used in these systems.
Cistern	Underground or sub-surface storage reservoir.
Delivery system	The delivery system is used to transport the water from the catchment surface (roof) to the storage reservoir. It usually consists of gutters and a downpipe.
Downpipe	The pipe that collects all the water transported from the roof surface by all gutters and is connected to the storage reservoir.
Evaporation	Process in which water passes from the liquid state into the vapour state.
Ferro cement	Construction method involving the reinforcement of cement mortar using wire and/or wire mesh.
First-flush device	The first rains collect the dust, bird droppings, leaves, etc., that lie on the roof surface. To prevent these pollutants and contaminants from getting into the storage tank, the first

rainwater containing the debris must therefore be diverted or flushed. Many RWH systems incorporate a 'first-flush' device for this purpose.

Precipitation	A general term for water which falls from the atmosphere as rain, snow or hail.
Rainwater catchment	Collection and storage of run-off primarily for domestic use and water supply.
Rainwater harvesting	A general term for most types of rainwater catchment for both agriculture and domestic supply.
Run-off	Run-off is the term applied to the water that flows away over the (soil) surface after rainfall.
Run-off coefficient	The ratio of the volume of water that runs off a surface to the volume of rain that falls on the surface.
Semi-arid	Fairly dry climate with average annual rainfall of about 500-750 mm, with high variability in rainfall.
Splash guard	Splash guards prevent rainwater from shooting over (conventional) gutters, resulting in loss of rainwater. Splash guards prevent this spillage.
Storage reservoir	The water collected from the catchment surface and transported by the delivery system will be stored in tanks or cisterns. Tanks can vary in size from a cubic metre (1000 litres)

up to hundreds of cubic metres for large reservoirs, but typically up to a maximum of 30 cubic metres for a domestic system at household level and 100 cubic metres for a system at community or school level.

Surface run-off

Rainfall run-off from ground surfaces as well as roof surfaces.

Water harvesting

An umbrella term for a range of methods of concentrating and storing rainwater run-off, including from roofs (rooftop harvesting), the ground (run-off harvesting) and from channel flow (floodwater harvesting).